

OPERATING AND MAINTENANCE INSTRUCTIONS

for the GOLD Air Handling Unit, Sizes 11-52

Applicable to Program Version 1.20 and newer versions



Contents

Section	Page	Section	Page
1. General	3	7. Description of the Other Functions	49
1.1 Field of Application	3	7.1 Cooling Energy Recovery	49
1.2 Mechanical Design	3	7.2 Intermittent Purging Operation.....	49
1.3 Built-in Control System	3	7.3 Heat Exchanger Rotation Monitor.....	49
1.4 Ready for Cooler and Reheater	3	7.4 Zero Calibration	49
1.5 Components of the Air Handling Unit.....	4	7.5 Low speed/High Speed Switching	49
2. Safety Precautions	7	7.6 Summer Night Cooling	49
2.1 General.....	7	7.7 Set Point Displacement.....	50
2.2 Safety Isolating Switch/Main Switch.....	7	7.8 High Speed Fan Operation Indication.....	50
2.3 Risks	7	7.9 External Input for High Speed Operation.....	50
2.4 Guards.....	7	7.10 External Input for Low Speed Operation.....	50
2.5 Qualifications	7	7.11 Anti-frosting Monitor Function	50
3. Commissioning	8	7.12 Three Types of Airflow Regulation.....	51
3.1 Basic Settings and Adjustments	8	7.13 Communication	51
3.2 Duct Calibration	9	7.14 Recooling the Reheater	51
3.3 To adjust the Adjusting Damper.....	9	7.15 Supply Airflow Regulation to min. Set Point.....	51
3.4 Commissioning Report	10	8. Alarms	52
4. Programming and Managing the Menus	16	9. Maintenance	61
4.1 Hand-held Terminal	16	9.1 To Change Filters.....	61
4.2 Menu Groups and Levels	16	9.2 Cleaning	62
4.3 Menu Button Captions and Symbols.....	16	10. Technical data	63
4.4 List of Functions	17	10.1 Dimensions	63
5. Menus for Operation, Temp, Flow and Calibration..	18	10.2 Electrical Data	66
5.1 Main Menu	19	10.3 El. Cubicle w. Ctrl Circuit Bd, Size 11,12 and 15 Units	67
5.2 Filter Calibration and Flow Adjustment Menu Group ...	20	10.4 El. Cubicle w. Ctrl Circuit Bd, Size 21-32 Units.....	68
5.3 Start Menu for Temp, Flow and Switching Clock ...	21	10.5 El. Cubicle w. Ctrl Circuit Bd, Size 42-52 Units.....	69
5.4 Switching Clock Menu Group.....	22	10.6 Wiring Diagram, Size 11 - 32 Units	70
5.5 Temperature Menu Group	23	10.7 Wiring Diagram, Size 42 - 52 Units	71
5.6 Flow Menu Group	25	10.8 Wiring to the Terminals, Size 11 - 52 Units.....	72
6. Menus for Functions, Entering Alarm Settings, Entering Cooler Settings, Running Manual Tests, Viewing Readings and Entering Control Settings	27	11. Assurance of compliance	73
6.1 Start Menu for Functions, Entering Alarm Settings, Entering Cooler Settings, Running Manual Tests, Viewing Readings and Entering Control Settings	28		
6.2 Functions Menu Group.....	28		
6.3 Alarm Menu Group	33		
6.4 Cooling Menu Group	36		
6.5 Manual Test Menu Group.....	39		
6.6 Read-only Menu Group.....	42		
6.7 Control Settings Menu Group.....	45		

1. General

1.1 Field of Application

The GOLD Air handling system is designed for comfort ventilation, primarily in public buildings, such as offices, schools and day nurseries, municipal buildings, shops, etc. The GOLD is also suitable for use in institutional kitchens and restaurants, for example, provided that the unit ventilates spaces in which similar activity is pursued.

It is important to consider the special features of the GOLD as you design it into the project, install, adjust and operate it in order to obtain all the benefits that GOLD System has to offer.

The unit in its basic version should be located indoors. If the air handling unit is installed outdoors, it must be fitted with the TBTA accessory.

This Document

These operating and maintenance instructions apply to the Swegon, Version B, Size 11 - 52, GOLD Air handling units. This document shall be used for servicing the air handling unit.

Caution! Always read the safety precautions in Section 2 about general risks and the qualifications required of service technicians. Carefully follow the installation instructions in each section.

The identification label specifying the size designation, version and manufacture number is affixed on the upper right-hand corner of the air handling unit. It is especially important that you keep a record of these specifications and be able to refer to them whenever you get in touch with Swegon.

1.2 Mechanical Design

The GOLD is available in models for seven airflow ranges. The external sheet metal surfaces are painted in a shade of beige and the handles, junction hood and decorative parts are graphite grey. The material inside the unit is mostly aluminium-zinc-plated sheet steel. The sheet metal panels are 1 mm thick with 50 mm thick intervening insulation. The air handling unit has supply air and exhaust air filters with Class F7 glass fibre medium. The rotary heat recovery section, of Turbo type, is variably speed controlled and has a temperature efficiency of up to 85%.

The supply and exhaust air fans are of GOLD Wing type, an axi-centrifugal fan with backward-curved blades. The GOLD 42 and 52 have two parallel fans in each airflow direction. The fans are direct driven and have frequency converters for variable control.

1.3 Built-in Control System

The control system is a microprocessor-based system incorporated into the air handling unit. It controls and regulates the fans, heat exchanger, temperatures, airflows, operating times and a large number of internal and external functions as well as alarms.

1.4 Ready for Cooling and Reheating

The GOLD Air handling system is also well suited for cooling air. The control functions are ready to be activated in the control system and cooling equipment is available as an accessory.

The GOLD can be used without any downstream air heater in many applications. Its efficient heat recovery and its unique control functions make this possible.

Nevertheless, under certain conditions, it will be necessary to heat the supply air. The control system also includes ready-to-use control functions for this purpose. And equipment for heating the supply air is available as an accessory.

1.5 The GOLD Components

1.5.1 Size 11/12 and 15 units

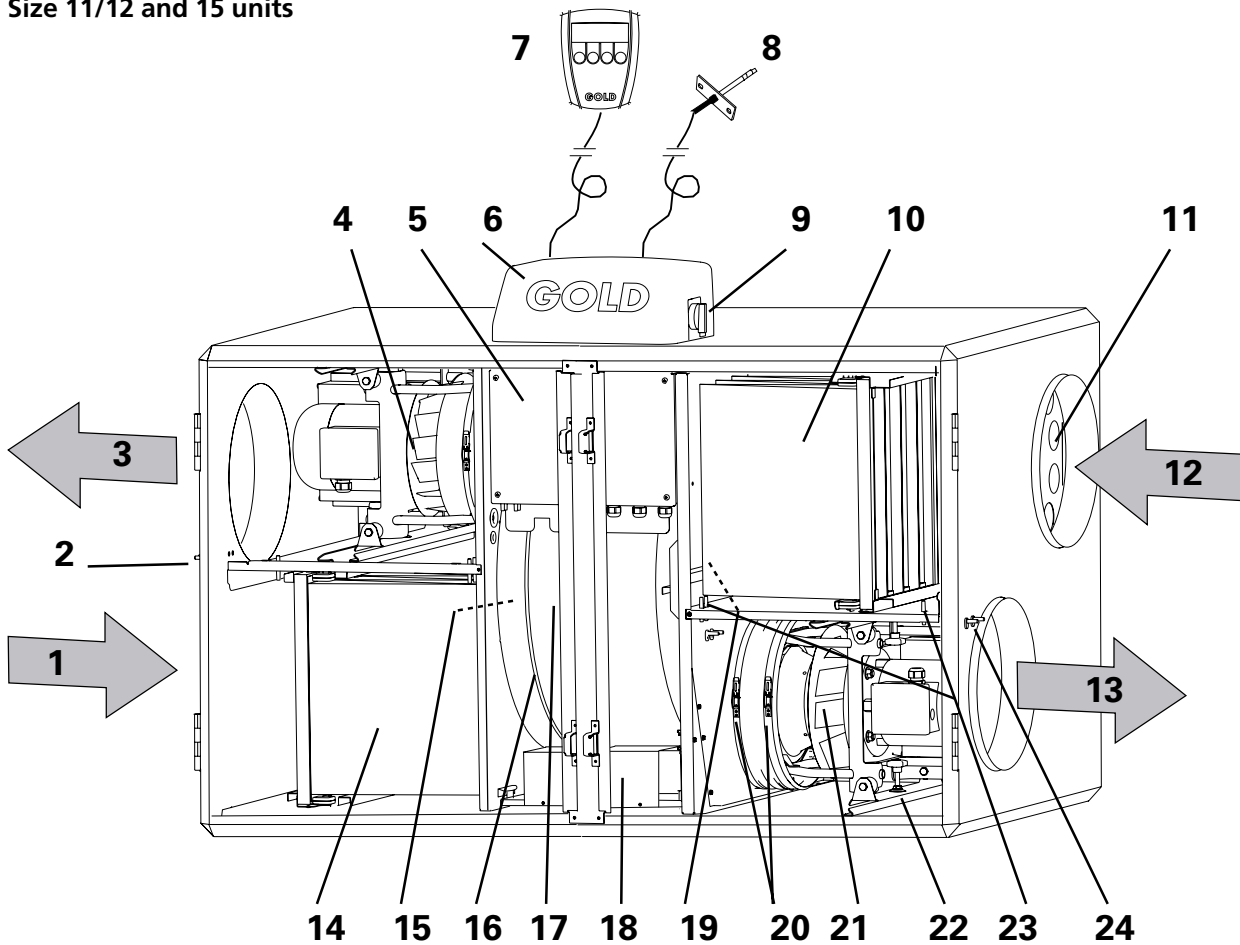

The air handling unit is supplied as a right-hand unit, i.e. with the airflow directions indicated by the arrows in the illustration. If you alter the installation to obtain a left-hand flow configuration, the components marked with an asterisk exchange function and name (i.e. they must be renamed accordingly if their function is for supply air or for exhaust air).

Airflow Directions/Location and Name of the Component

- | | | | |
|----|---|----|--|
| 1 | OUTDOOR AIR* (Exhaust air - left-hand airflow config.) | 12 | EXHAUST AIR* (Outdoor air - left-hand airflow config.) |
| 2 | Pressure measurement tappings (For internal pressure balance readings in a left-hand airflow config.) | 13 | SUPPLY AIR* (Extract air - left-hand airflow config.) |
| 3 | EXTRACT AIR* (Supply air - left-hand airflow config.) | 14 | Supply air filter* |
| 4 | Exhaust air fan * | 15 | Outdoor air temperature sensor* |
| 5 | Fuse and control circuit board cubicle | 16 | Drive belt of the heat recovery section |
| 6 | Junction hood | 17 | Heat recovery section |
| 7 | Hand-held terminal | 18 | Drive motor for the heat recovery section |
| 8 | Supply air temperature sensor (to be fitted inside the supply air duct) | 19 | Extract air temperature sensor* |
| 9 | Main switch/Safety isolating switch | 20 | Clamps on flexible connection at fan inlet |
| 10 | Exhaust air filter* | 21 | Supply air fan* |
| 11 | Adjustment plate (Located in left-hand filter section in a left-hand airflow configuration) | 22 | Locking knob for withdrawable fan mount |
| | | 23 | Measurement tappings, fall of pressure in filter. |
| | | 24 | Pressure measurement tappings (For internal pressure balance readings in a right-hand airflow config.) |

1.5.2 Size 21/22 and 31/32 units

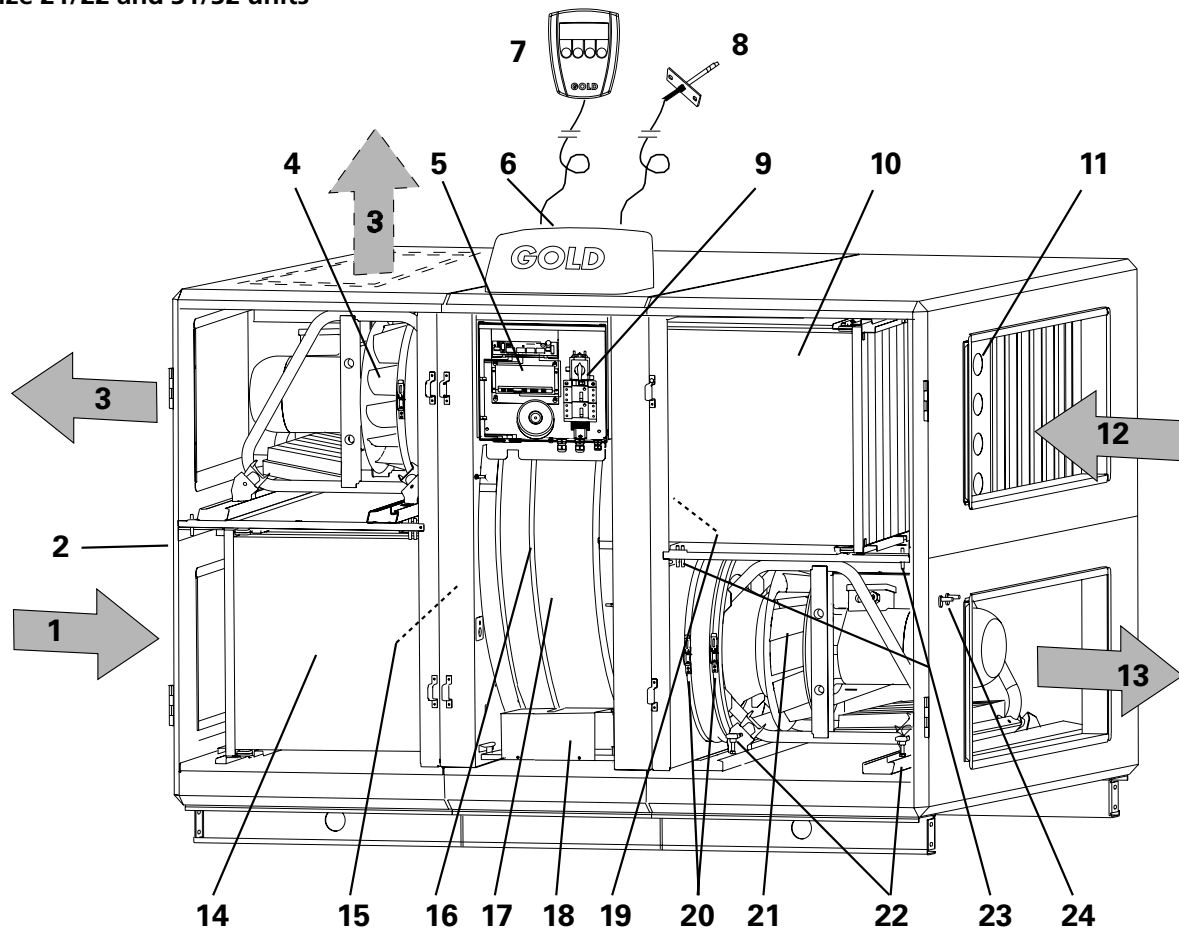

The air handling unit is supplied as a right-hand unit, i.e. with the airflow directions indicated by the arrows in the illustration. If you alter the installation to obtain a left-hand flow configuration, the components marked with an asterisk exchange function and name (i.e. they must be renamed accordingly if their function is for supply air or for exhaust air).

Airflow Directions/Location and Name of the Component

- | | |
|---|--|
| <ul style="list-style-type: none"> 1 OUTDOOR AIR* (Exhaust air - left-hand airflow config.) 2 Pressure measurement tappings (For internal pressure balance readings in a left-hand airflow config.) 3 EXTRACT AIR* (Supply air - left-hand airflow config.) 4 Exhaust air fan* 5 Fuse and control circuit board cubicle 6 Junction hood 7 Hand-held terminal 8 Supply air temperature sensor (to be fitted inside the supply air duct) 9 Main switch/Safety isolating switch 10 Exhaust air filter* 11 Adjustment plate (Located in left-hand filter section in a left-hand airflow configuration) | <ul style="list-style-type: none"> 12 EXHAUST AIR* (Outdoor air - left-hand airflow config.) 13 SUPPLY AIR* (Extract air - left-hand airflow config.) 14 Supply air filter* 15 Outdoor air temperature sensor* 16 Drive belt of the heat recovery section 17 Heat recovery section 18 Drive motor for the heat recovery section 19 Exhaust air temperature sensor* 20 Clamps on flexible connection at fan inlet 21 Supply air fan* 22 Locking knob for withdrawable fan mount 23 Measurement tappings, fall of pressure in filter. 24 Pressure measurement tappings (For internal pressure balance readings in a right-hand airflow config.) |
|---|--|

1.5.3 Size 42 and 52 units

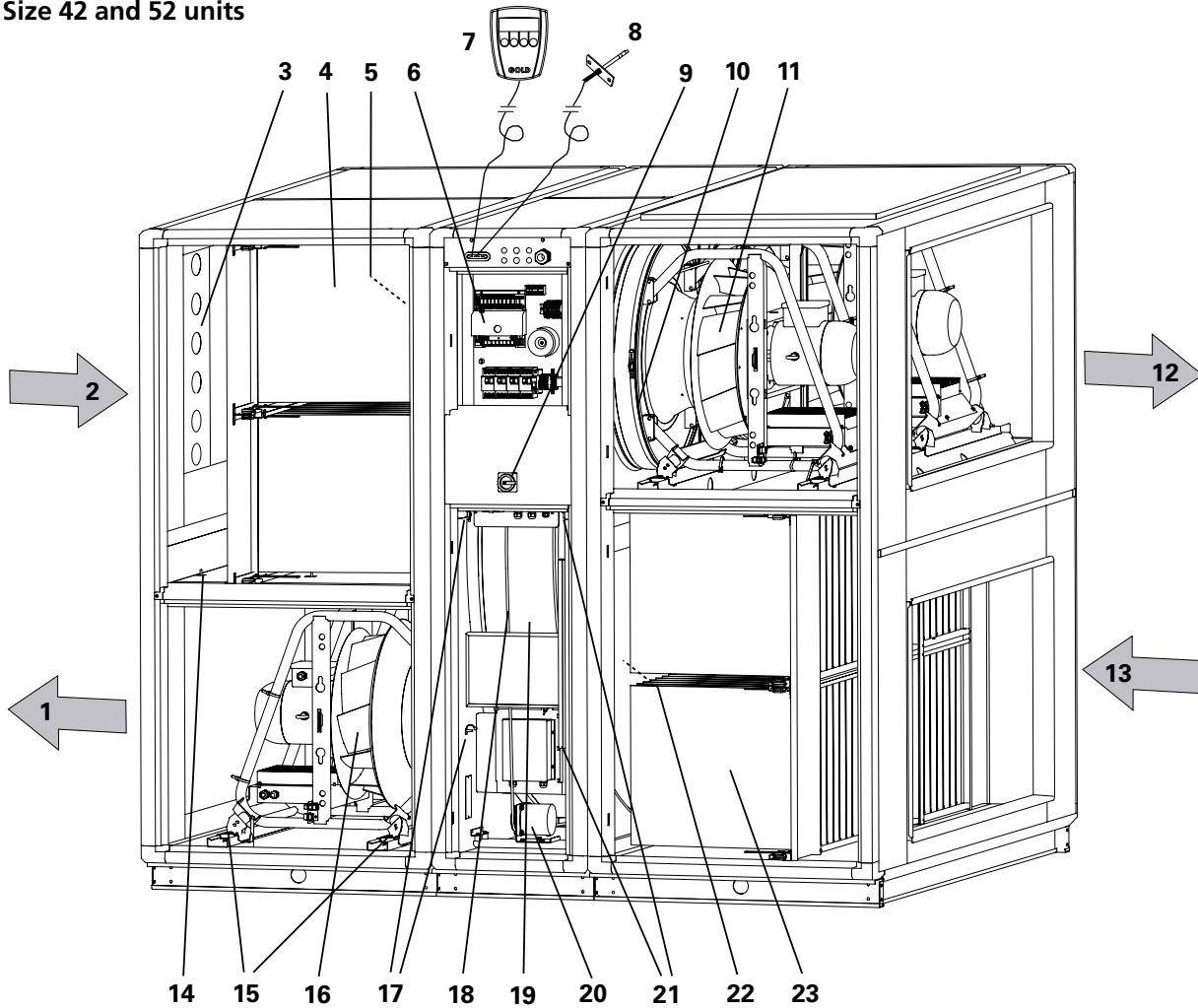

A left-hand unit is shown above. If your unit is a right-hand model, the function and designation of the components followed by an asterisk, i.e. those designated according to whether their function is for supply air or for extract air, change places.

Airflow Directions/Location and Name of the Component

- | | | | |
|----|---|----|--|
| 1 | SUPPLY AIR* (Extract air - right-hand airflow config.) | 13 | OUTDOOR AIR* (Exhaust air - right-hand airflow config.) |
| 2 | EXHAUST AIR* (Outdoor air - right-hand airflow config.) | 14 | Measurement tappings, fall of pressure in filter. |
| 3 | Adjustment plate (Located in right-hand filter section in a right-hand airflow configuration) | 15 | Locking knob for withdrawable fan moun |
| 4 | Exhaust air filter* | 16 | Supply air fan* |
| 5 | Exhaust air temperature sensor* | 17 | Pressure measurement tappings (For internal pressure balance readings in a left-hand airflow config.) |
| 6 | Fuse and control circuit board cubicle | 18 | Drive belt of the heat recovery section |
| 7 | Handterminal | 19 | Heat recovery section |
| 8 | Supply air temperature sensor (to be fitted inside the supply air duct) | 20 | Drive motor for the heat recovery section |
| 9 | Huvud-/Säkerhetsbrytare | 21 | Pressure measurement tappings (For internal pressure balance readings in a right-hand airflow config.) |
| 10 | Clamps on flexible connection at fan inlet | 22 | Outdoor air temperature sensor* |
| 11 | Exhaust air fan* | 23 | Supply air filter* |
| 12 | EXTRACT AIR* (Supply air - right-hand airflow config.) | | |

2. SAFETY PRECAUTIONS

2.1 General

All staff concerned must acquaint themselves with these instructions before beginning any work on the unit. Any damages to the unit or its components caused by improper handling or misuse by the purchaser or fitter cannot be considered subject to guarantee if these instructions have not been followed.

2.2 Safety Isolating Switch/

Main Switch

Size 11/12 and 15: The safety-isolating switch is situated high on the outside of the cubicle.

Sizes 21/21 and 31/32: The safety-isolating switch is situated behind the inspection door of the heat recovery section (the door in the centre section).

Sizes 42 and 52: The safety switch is situated inside the unit on a fixed section between the inspection doors of the heat exchanger.

The safety-isolating switch must not be used for starting or stopping the unit. Use the stop button on the hand-held terminal to stop the unit.

Always switch off the safety-isolating switch before servicing the unit if not otherwise specified in the pertinent instructions.

2.3 Risks

WARNING! Before carrying out any work, make sure that the power supply to the unit has been isolated.

Risk areas with rotating parts

Typical rotating parts are fan impellers and drive pulleys in the heat recovery section. The heat recovery section drive pulleys in the size 21, 22, 31 and 32 units are equipped with a guard. The lockable inspection doors serve as guards for the fans and for the heat recovery section drive pulleys in the size 11, 12, 15, 42 and 52 units. If the fan outlets aren't connected to any duct, they must be fitted with a protective screen (steel wire mesh).

The inspection doors on the filter/fan sections must not be opened while the air handling unit is operating.

Under normal operating conditions, use the stop button on the hand-held terminal to stop the air handling unit.

Wait until the fans have stopped rotating before opening the inspection door.

Keep in mind that the air pressure inside the filter/fan section is positive.

2.4 Safety Guards

The cubicle cover panel serves as an anti-contact guard on the size 11, 12 and 15 units. On the size 21–32 units, the protecting plate of the electrical equipment cubicle serves as a safety guard.

Only a qualified electrician or trained service technicians shall be allowed to remove the safety guards.

Open the safety switch to isolate the power supply to the air handling unit before you remove the safety guard.

As long as the air handling unit is operating, the guards must always be secured, all the inspection doors must be closed and the junction hood on the top of the unit casing must be fitted.

2.5 Qualifications

Only qualified electricians or trained service technicians are authorized to unscrew fasteners and remove guards (protective panels) in conjunction with the electrical installation of the air handling unit or wiring external functions. Only service technicians trained by Swegon are authorized to modify the air handling unit in any way.

3. COMMISSIONING

3.1 Basic Settings and Adjustments

The following is a description of the sequence for starting up the unit for the first time. **NOTE!** The hand-held terminal, air supply temperature sensor, adjusting plates, document pocket, decals and instructions are packaged in a separate carton inside the unit behind the left-hand inspection door.

The hand-held terminal is used for programming how the unit is to operate. The air handling unit control system has been preset at the factory and is thus ready-to-operate as soon as all the electrical wiring has been completed. The various keying operations on the hand-held terminal are described in detail in Section 4.

3.1.1 Commissioning Report

All the settings entered in the unit display, must be recorded in the Commissioning Report. See Section 3.4. The report can also be used as a checklist to determine which functions can be adjusted. The initial factory settings and reference to the section of the instructions, in which the relevant menus described, are specified in the report.

3.1.2 Selecting the language

When the unit is connected and the main switch is switched on for the first time, a language menu will appear in the display of the hand-held terminal. (The menu is described in Section 6.2.9)

- Select the appropriate language by pressing the arrow up or arrow down button. Then confirm your selection by pressing the SET button.

3.1.3 Selecting the operating mode

After you've selected a language, the menu image will switch to the main menu (described in Section 5.1). The operating mode selected is displayed on third line in the menu. In this case STOP is displayed.

- To change to the desired operating mode, press the MAN or AUTO button.

Normally, the unit is meant to operate in the AUTO OP mode. In this mode, the switching clock manages all switching between high and low-speed operation.

3.1.4 Setting the switching clock

Press the INST button and then the  button to advance to the switching clock menu (described in Section 5.4.).

- First program the correct day of the week, time and date.
- Then program the required switch in and switch out times of the switching clock.

3.1.5 Further settings

Use the Commissioning Report as an aid for setting the required air flows, temperatures, flow regulation, etc. All functions are listed in alphabetic order in Section 4.4.

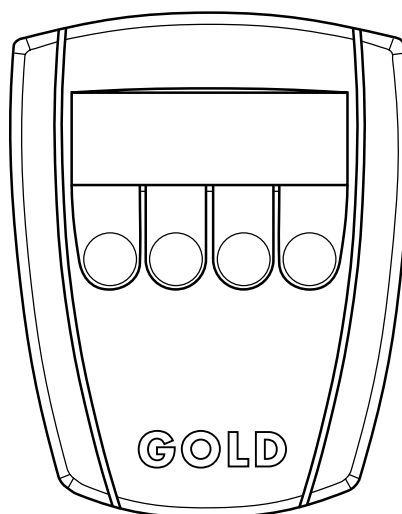

Hand-held terminal

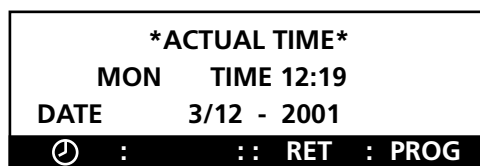
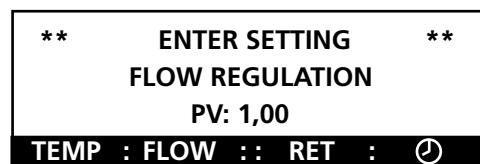
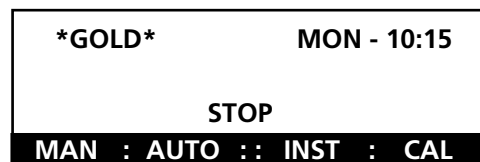

3.2 Filter Calibration

The airflow across the filters must be calibrated after the ducting system and the pressure adjustment damper have been completely adjusted and every time the filters are changed. NOTE! The filters have to be clean.

To activate the filter calibration mode, press the **CAL** button in the main menu. Then press and hold the **SET** button for at least 5 seconds. The filters will then be automatically calibrated. After a test is carried out, the GOLD will return to normal operation. See Section 5.2, as well.

3.3 To Adjust the Adjusting Damper

To adjust the pressure balance

The pressure balance in the unit should be adjusted by repositioning the adjustment damper plates to enable a leakage air flow from the supply air to the exhaust air. There are two pressure measurement tappings on the outside of the filter/fan sections of the unit. One tapping is white (+) and the other is blue (-). See Fig. 2 below. The tappings are used to measure the negative pressure in the supply air and the exhaust air levels respectively.

- Connect the flow measurement tappings for +(white tapping) and - (blue tapping) to a manometer oother type of pressure gauge and measure both pressures.

NOTE! Measure the negative pressure at both tappings!

Pressure readings

The negative pressure in the exhaust air passage (blue tapping) should be more negative or just as negative as that in the supply air passage (white tapping).

If the reading is correct

If the negative pressure in the exhaust air passage is just as negative or up to 20 Pa more negative than the negative pressure in the supply air passage, no further adjustment is needed.

If the reading differs

If the negative pressure in the exhaust air passage (-) is less negative than that in the supply air passage (+), the adjustment damper must be fitted in the unit and then be adjusted as follows:

- First switch off the unit with the stop button on the hand-held terminal.
- Wait until the fans have stopped before opening the inspection door (to avoid overpressure).
- Open the safety switch to isolate the power supply to the unit.
- Open the inspection door of the exhaust air filter/supply air fan section.
- Slightly push the damper plates in the exhaust air intake toward one another.
- Close the inspection door.
- Start the unit by pressing the MAN or AUTO button.
- Measure the pressures. Repeat until the negative pressure in the exhaust air passage is just as negative or up to 20 Pa more negative than the negative pressure in the supply air passage (0-20 Pa).

If the negative pressure in the exhaust air section is more than 20 Pa more negative than the negative pressure in the supply air section, in spite of the fact that the throttling damper is completely open, the throttling damper should be moved to the outdoor air inlet.

Finish by calibrating the filters!

Sizes 11/12 and 15

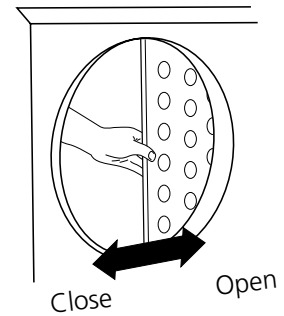

Sizes 21/22, 31/32, 42 and 52

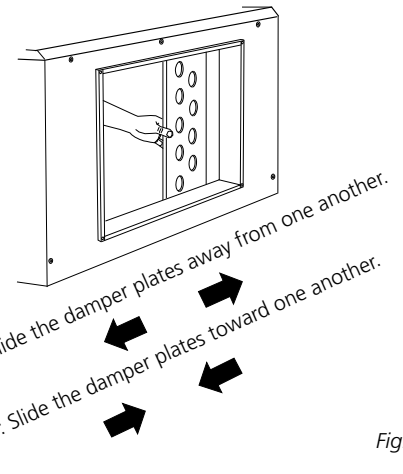
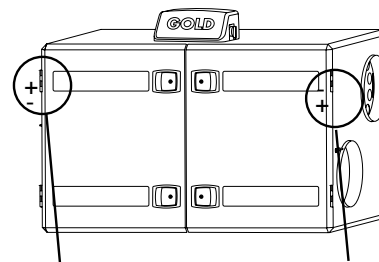

Fig. 1

Sizes 11/12 and 15



(These pressure measurement tappings are used for a unit with a left-hand flow configuration.)

These pressure measurement tappings are used for a unit with a right-hand flow configuration. = Factory setting.

Sizes 21/22 and 31/32

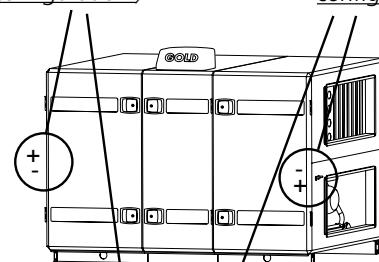

Sizes 42 and 52

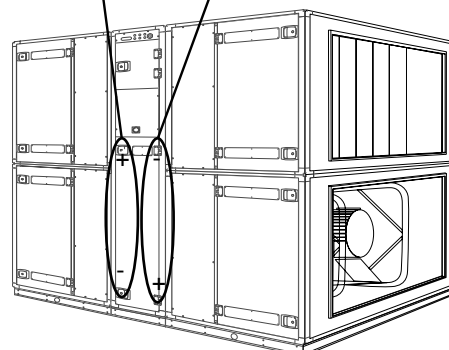

Fig. 2

3.4. Commissioning Report, Page 1

The commissioning report can be downloaded as an Excel file from: www.swegon.se.

Item, location, air handling unit, etc.

.....
.....
.....
.....

Switching clock, current time preset
Filter calibration has been carried out

Program version

Comments:

.....
.....
.....

Installation work carried out by:

Date
Company
Name

Project design work carried out by:

Date
Company
Name

Adjustments carried out by:

Date
Company
Name

3.4. Commissioning Report, Page 2

Function	Factory preset value	Adjusted value
Temperature		
Temp, control function	1. ERS <input checked="" type="checkbox"/> 2. Supply air <input type="checkbox"/> 3. Exhaust air <input type="checkbox"/>	1. ERS <input type="checkbox"/> 2. Supply air <input type="checkbox"/> 3. Exhaust air <input type="checkbox"/>
Differential, supply/exhaust air(°C)	3.0
Increment	2
Breakpoint(°C)	22.0
Set point (°C)	20.0 20.0
Min. supply air temp. (°C)	15.0
Max. supply air temp. (°C)	25.0
Flow		
Fan regulation	1. Flow <input checked="" type="checkbox"/> 2. VAV <input type="checkbox"/> 3. Forc. <input type="checkbox"/>	1. Flow <input type="checkbox"/> 2. VAV <input type="checkbox"/> 3. Forc. <input type="checkbox"/>
Type of VAV regulation	1. Pressure <input checked="" type="checkbox"/> 2. Demand <input type="checkbox"/>	1. Pressure <input type="checkbox"/> 2. Demand <input type="checkbox"/>
Flow, low speed, supply air**
exhaust air**
Flow, high speed, supply air****
exhaust air****
Flow, max. speed, supply air********
exhaust air********
Flow, low speed, supply air*****
exhaust air*****
VAV, low speed, supply air (%)	25
exhaust air (%)	25
VAV, high speed, supply air (%)	35
exhaust air (%)	35
Time channel function		
	1.Low - high <input checked="" type="checkbox"/> 2. Stop - low - high <input type="checkbox"/>	1. Low - high <input type="checkbox"/> 2. Stop - low - high <input type="checkbox"/>
Cooling functions		
Cooling unit control	Shut down <input checked="" type="checkbox"/> 1. 0-10V <input type="checkbox"/> 2. On/off <input type="checkbox"/>	Shut down <input type="checkbox"/> 1. 0-10V <input type="checkbox"/> 2. On/off <input type="checkbox"/>
Cooling on/off function	1 stage <input checked="" type="checkbox"/> 2 stages <input type="checkbox"/> 3 stages, bin <input type="checkbox"/>	1 steg <input type="checkbox"/> 2 steg <input type="checkbox"/> 3 steg bin <input type="checkbox"/>
Exercise, cooling relay 1	0
cooling relay 2	0
Outdoor temp. limit, stage 1 (°C)	8.0
stage 2 (°C)	10.0
stage 3 (°C)	12.0
Re-start time (min.)	8
Neutral zone (°C)	0.5

Function	Factory preset value	Adjusted value
Min supply air flow (m ³ /s) ***** *****
Min. exhaust air flow (m ³ /s) ***** *****
Forced (boosted) cooling	1. Disabled <input checked="" type="checkbox"/> 2. Comfort <input type="checkbox"/> 3. Economy <input type="checkbox"/>	1. Disabled <input type="checkbox"/> 2. Comfort <input type="checkbox"/> 3. Economy <input type="checkbox"/>

The values are applicable to size 11, 12, 15, 21, 22, 31, 32, 42 and 52 units respectively and are quoted in m³/s

*) 0.10/0.20/0.30/0.30/0.55/0.85/1.10/11,70/2,20

***) 0.20/0.30/0.40/0.60/1.00/1.65/2.20/13,40/4,60

****) 0.30/0.50/0.60/0.90/1.40/2.50/3.30/14,30/15,80

*****) Applicable only in combination with boosted cooling (Coolforcing).

*****) In combination with a VAV only: 0.05/0.08/0.10/0.11/0.22/0.40/0.60/10,80/1,00

*****) 0.05/0.08/0.10/0.11/0,22/0.40/0.60/10,80/1,00

3.4. Commissioning Report, Page 3

In Report is Factory preset value mentioned. 0 is that the function is not chosen, 1 is that the function is chosen.

Function	Factory preset value	Adjusted value	Function	Factory preset value	Adjusted value
Summer night cooling	0	Alarm limit temperature		
Start time	23:00	Min. exhaust air temp.	15.0
Switches in at exhaust air temp. (°C)	22.0	Temp. below supply air set point	5.0
Switches out at exhaust air temp. (°C)	16.0	Fire alarm function		
Switches out at outdoor air temp. (°C)	10.0	Internal fire protection	0
Outdoor air temp. compensation	0	Exhaust air when fire	0
<i>Temperature:</i>			External alarm		
Winter compensation (°C)	3.0	Time delay alarm 1 (s)	10
Summer compensation (°C)	2.0	Alarm when closing. Alarm 1	1
X1 end point winter (°C)	-20.0	Time delay alarm 2 (s)	10
X2 starting point winter (°C)	10.0	Alarm when closing. Alarm 2	1
X3 starting point summer (°C)	25.0	Min./max. adjustment		
X4 end point summer (°C)	40.0	Set point, supply/exhaust air (°C)	15.0/25.0
<i>Flow:</i>			Min. limit, supply air (°C)	13.0/18.0
Flow comp. winter (%)	0.0	Max. limit, supply air (°C)	20.0/40.0
X1 end point winter (°C)	-20.0	Breakpoint, ERS regulation (°C)	15.0/23.0
X2 starting point winter (°C)	10.0	Difference, supply air- /exhaust air (°C)	1.0/5.0
Time delay			Regulation speed		
External high speed (hrs)	0:00	Supply air controller temperature	2
External low speed (hrs)	0:00	Exhaust air controller temperature	2
Set point displacement	0	Supply air controller, VAV	5
Auto change summer time	1	Exhaust air controller, VAV	5
Circulation pump heat			Switch frequency		
Pump function	1	Frequency converter, supply air (kHz)	4.5
Exercise mode pump	1	Frequency converter, exhaust air (kHz)	4.5
Flow unit	m ³ /s	VAV SA reg. to min set point	0.0
Language selection	English	Neutral zone supply air regulation		
Service alarm			down to set point (°C)	0.0
Service period (months)	12	Start up time (min)	3
Alarm limit filter					
Supply air filter (units)	10*			
Exhaust air filter (units)	10*			

* Recommended final pressure drop

Adjustment time channels switching-clock			Day of the week	
Channel	Operation drop	Times		
No. 1	Low <input type="checkbox"/> High <input type="checkbox"/> : - :	-
No. 2	Low <input type="checkbox"/> High <input type="checkbox"/> : - :	-
No. 3	Low <input type="checkbox"/> High <input type="checkbox"/> : - :	-
No. 4	Low <input type="checkbox"/> High <input type="checkbox"/> : - :	-
No. 5	Low <input type="checkbox"/> High <input type="checkbox"/> : - :	-
No. 6	Low <input type="checkbox"/> High <input type="checkbox"/> : - :	-
No. 7	Low <input type="checkbox"/> High <input type="checkbox"/> : - :	-
No. 8	Low <input type="checkbox"/> High <input type="checkbox"/> : - :	-

3.4. Commissioning Report, Page 4

Alarm No	Function	Factory adjusted value			Adjusted value		
		Priority	Alarm ind.	Influence	Priority	Alarm ind.	Influence
		0 = blocked 1 = A alarm 2 = B alarm	0 = from 1 = on	0 = operation 1 = stop	0 = blocked 1 = A alarm 2 = B alarm	0 = from 1 = on	0 = operation 1 = stop
1	External fire alarm	1	1	1*
2	Internal fire alarm	1	1	1*
3	Anti-frosting temp. below alarm limit	1	1	1*
4	Rotation monitor heat exchanger tripped	1	1	1**
5	Anti-frosting sensor faulty	1	1	1*
6	Supply air sensor faulty	1	1	1
7	Exhaust air sensor faulty	1	1	1
8	Outdoor sensor faulty	2	1	0
9	No comm. w heat exch controller	1	1	1
10	No comm. w supply air frequency converter	1	1	1
11	No comm. w exhaust air frequency converter	1	1	1
12	Over current in supply air frequency converter	1	1	1
13	Over current in exhaust air frequency converter	1	1	1
14	Under current in supply air frequency converter	1	1	1
15	Under current in exhaust air frequency converter	1	1	1
16	Fault, low current in supply air frequency converter	1	1	1
17	Fault, low current in exhaust air frequency converter	1	1	1
18	Over temperature in supply air frequency converter	1	1	1
19	Over temperature in exhaust air frequency converter	1	1	1
20	No comm. w supply air frequency converter	1	1	1
21	No comm. w exhaust air frequency converter	1	1	1
22	Over current in supply air frequency converter	1	1	1
23	Over current in exhaust air frequency converter	1	1	1
24	Under current in supply air frequency converter	1	1	1
25	Under current in exhaust air frequency converter	1	1	1
26	Fault, low current in supply air frequency converter	1	1	1
27	Fault, low current in exhaust air frequency converter	1	1	1
28	Over temperature in supply air frequency converter	1	1	1
29	Over temperature in exhaust air frequency converter	1	1	1
30	Alarm Cooler	2	1	0
33	Over temperature in heat exchanger regulation	1	1	1
34	Electrical coil tripped	1	1	1
35	Exhaust air temp. below alarm limit	1	1	1
36	Supply air temp. below set point	1	1	1
37	External alarm no. 1 tripped	1	1	0
38	External alarm no. 2 tripped	2	1	0
39	Supply air duct pressure below set point	2	1	0
40	Exhaust air duct pressure below set point	2	1	0

Alarm No	Function	Factory adjusted value			Adjusted value		
		Priority	Alarm ind.	Influence	Priority	Alarm ind.	Influence
		0 = blocked 1 = A alarm 2 = B alarm	0 = from 1 = on	0 = operation 1 = stop	0 = blocked 1 = A alarm 2 = B alarm	0 = from 1 = on	0 = operation 1 = stop
41	Supply air duct pressure above set point	2	1	0
42	Exhaust air duct pressure above set point	2	1	0
43	Supply air flow below set point	2	1	0
44	Exhaust air flow below set point	2	1	0
45	Supply air flow above set point	2	1	0
46	Exhaust air flow above set point	2	1	0
47	Supply air filter dirty	2	1	0
48	Exhaust air filter dirty	2	1	0
49	Service period exceeds alarm limit	2	1	0

* Not adjustable, always stops the unit

** Not adjustable, stops the unit if temperature is below +5°C

4. PROGRAMMING AND MANAGING THE MENUS

4.1 Hand-held Terminal

4.1.1 General

The hand-held terminal consists of an encapsulated micro control terminal designed for connection to the unit across a 3 m long cable with quick connector.

The hand-held terminal has an illuminated display and 4 buttons. A red lamp for indicating alarms is integrated into one of the buttons.

4.1.2 Display and Buttons

All the air flow, control function, temperature and operating time settings, for example, can be read in plain text in the display.

The information is presented in various menu images. The buttons are used to advance to various menus, and to alter settings or to activate functions in the various menus. The main menu is normally displayed, if no other menu has been selected. If the operator doesn't revert to the main menu manually, the terminal will automatically return to the main menu after 30 minutes if no button is pressed.

The main menu is normally displayed, if no other menu has been selected. If the operator doesn't revert to the main menu manually, the terminal will automatically return to the main menu after 30 minutes if no button is pressed.

4.2 Menu Groups and Levels

The menus of the display are divided into various menu groups and levels. The structure of the menus and the order of their management are logical and only current parameters for the function selected are displayed.

All the accessible menus are described separately in Sections 5 and 6. The menus are described in their order of presentation in the display.

The menu groups are arranged according to their application. The structure of the menus is presented in the beginning of Sections 5 and 6.

There are several types of menus: the main menu, start menus, menu groups, menus and submenus.

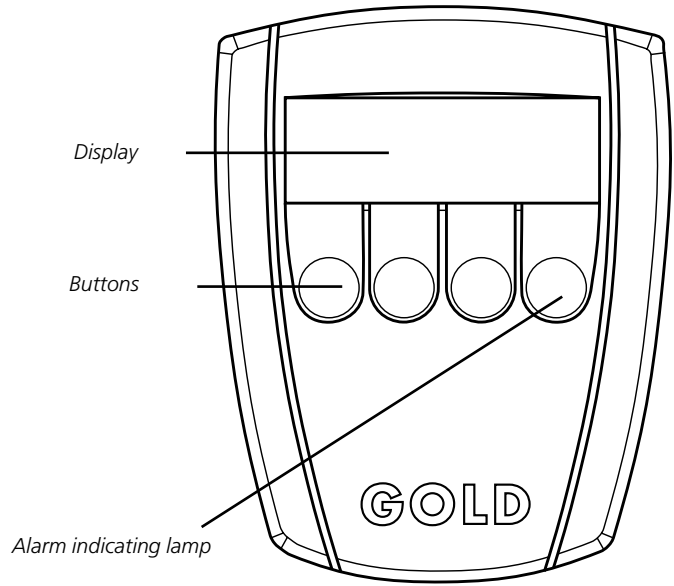

4.3 Menu Button Captions and Symbols

The most commonly occurring button functions are described below. (Should the buttons have other functions in some separate menu, this will be explained in the section for the relevant menu).

- ↓ To single step forward to the next menu in the group.
- ↑ To single step backward to the previous menu in the group.
- RET To return to the previous menu level (main or start menu).
- PROG Switches over to the submenu of the menu displayed (alter-settings mode).
- + To increase the value of the highlighted digits.
- To decrease the value of the highlighted digits.
- To single step forward to highlight new digits/line. After the last digits/line, the image will return to the read-only mode in the menu.
- ← To single step backward to highlight new digits/line. After the first digits/line, the image will return to the read-only mode in the menu.

Typical button captions and symbols

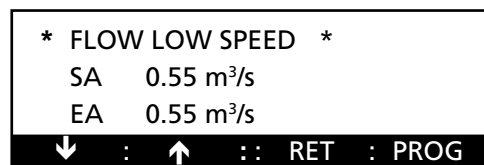

4.4 List of Functions

The list contains the control system functions arranged in alphabetical order with reference to the section in which the relevant menu is described

Function	Section
Actual time	5.4.1
Airflow adjustment	5.2.2
Alarm history	6.6.11
Alarm settings, menu group	6.3
Alarm settings, priority, ind. lamp, and function	6.3.6
Alarm, quick readings	6.6.10
Auto operation	5.1
Boosted airflow (forcing)	6.2.2
Boosted cooling (forcing), economy	6.4.5
Boosted cooling, comfort	6.4.5
Boosted cooling, selection function	6.4.5
Circulation pump, cooling circuit	6.4.2
Circulation pump, heating circuit	6.2.9
Control sequence, temperature, readings	6.6.5
Control settings menu group	6.7
Cooling relay 1 and 2, test	6.5.5
Cooling settings, menu group	6.4
Cooling settings, selection function	6.4.1
Cooling, 0-10 V	6.4.1
Cooling, control signal test	6.5.5
Cooling, min SA flow	6.4.6
Cooling, on/off	6.4.1
Direction of air flow, AHU, readings	6.6.12
ERS regulation	5.5.2
Exercise, cooling circuit pump	6.4.2
Exercise, heating circuit pump	6.2.9
Exhaust air fan signal, readings	6.6.6
Exhaust air fan speed, test	6.5.2
Exhaust air flow, test	6.5.2
Exhaust air regulation	5.5.3
External alarm 1 and 2	6.3.5
External alarm 1 and 2 status input, readings	6.6.8
External fire/smoke status input, readings	6.6.8
External high speed status input, readings	6.6.8
External high speed time delay	6.2.7
External low speed status input, readings	6.6.8
External low speed time delay	6.2.7
External stop status input, readings	6.6.8
Factory setting	6.7.7
Fan regulation selection function	6.2.2
Fan size SA and EA, readings	6.6.13
Feed-back control speed, temperature	6.7.2
Feed-back control speed, VAV	6.7.2
Filter calibration	5.2.1
Filters, actual status, SA and EA	6.6.9
Filters, alarm limit, SA and EA	6.3.2
Fire alarm, exhaust air in event of fire	6.3.4
Fire alarm, internal fire protection	6.3.4
Flow readings	5.6.1, 6.6.3
Flow unit	6.2.10
Flow, current set point, EA control	6.6.4
Flow, current set point, SA control	6.6.4
Flow, fan speed regulation	6.2.2
Flow, high speed, SA and EA	5.6.3
Flow, low speed, SA and EA	5.6.2
Flow, max. speed, SA and EA	5.6.4
Flow, min/max. speed, SA and EA	5.6.5
Functions, menu group	6.2
Group alarm, test	6.5.6
Heat exchanger motor signal, readings	6.6.7
Heat exchanger rotor, test	6.5.3
Heat relay, test	6.5.4
High speed output, test	6.5.6
In-operation indication output, test	6.5.6
In-operation time, AHU, readings	6.6.12
Language selection	6.2.11
Level for users, menu structure	5
Level for ventilation technicians, menu structure	6
Main menu	5.1
Manual operation	5.1
Manual test menu group	6.5
Neutral zone, heating/cooling	6.4.4
Neutral zone, supply air control to min. set point	6.7.6
Outdoor temperature compensation	6.2.6
Outdoor temperature compensation Breakpoints flow	6.7.4
Outdoor temperature compensation Breakpoints temp	6.7.3
Outdoor temperature limited cooling	6.4.3
Readings and regulation adjustment	6.1
Read-only menu group	6.6
Re-heating coil, type, readings	6.6.8
Re-heating, test	6.5.4
Re-start time, cooling	6.4.4
Service period	6.3.1
Set point displacement	6.2.8
Set point displacement input signal readings	6.6.8
Start menu for functions, alarm, cooling, test, Start menu for temp, flow and switching clock	5.3
Starting period	6.7.6
Stop 5.1	
Summer /winter time	6.2.8
Summer night cooling	6.2.5
Supply air fan signal, readings	6.6.6
Supply air flow, test	6.5.1
Supply air regulation	5.5.4
Supply air speed, test	6.5.1
Switching clock	5.4.2
Switching clock function selection	6.2.4
Switching frequency	6.7.5
Temperature set point, current Exhaust air controller	5.5.1, 6.6.2
Temperature set point, current Supply air controller	5.5.1, 6.6.2
Temperature, alarm limit, min. EA	6.3.3
Temperature, alarm limit, SA below set point	6.3.3
Temperature, min./max. settings	6.7.1
Temperature, readings	5.5.1, 6.5.7, 6.6.1
Temperature, regulation function selection	6.2.1
Time channel	5.4.2
VAV regulation	6.2.2
VAV regulation, demand	6.2.3
VAV regulation, high speed, SA and EA set point	5.6.6
VAV regulation, low speed, SA and EA set point	5.6.6
VAV regulation, pressure	6.2.3
VAV regulation, type	6.2.3
VAV SA reg. to min. set point	6.7.6
VAV/boosted (forcing) input signal SA and EA, readings	6.6.8

5. MENUS FOR OPERATING MODE, TEMP. FLOW AND CALIBRATION

This menu section is also called the user level and is intended for use by the operations personnel.

The menus that can be found under INST (for temperature, flow and switching clock) and under calibration in the main menu are described in this section.

These menus enable you to control the unit (manual, auto operation or stop), see the actual (current) time and switching clock functions, carry out filter calibration after replacing the filters and start up the air handling unit. The type of regulation selected for fan operation is displayed and you can view temperature and flow readings and enter temperature and flow settings.

N.B! Unless otherwise specified in the relevant menu section, the menu buttons will function normally as described in Section 4.3.

The Menu Structure

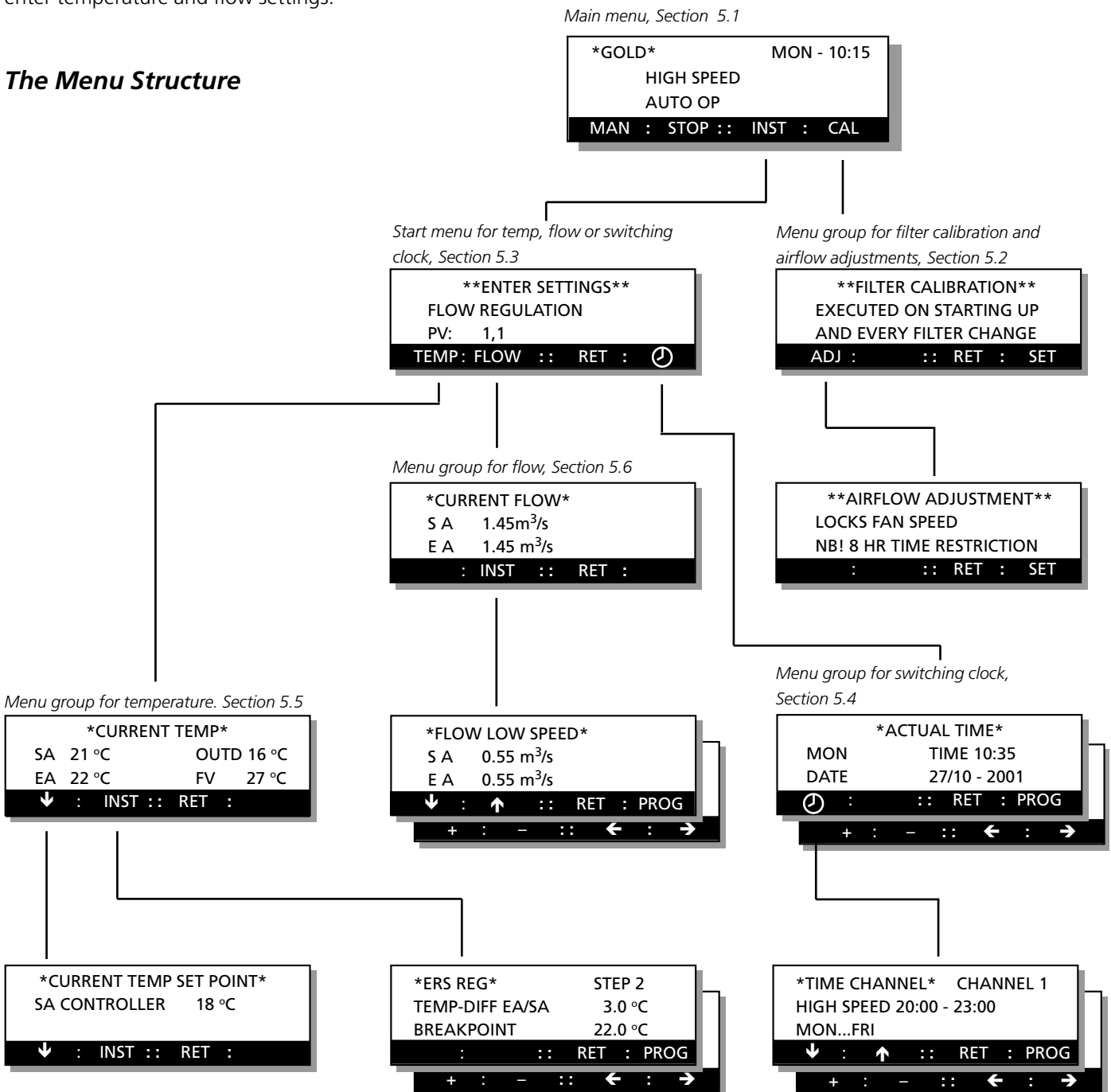

5.1 Main Menu

The contents in this menu vary depending on the type of operation selected, other functions that influence the actual (current) flow and any alarms that may have tripped.

The first line shows the day of the week and the actual (current) time.

The second line shows how the unit is currently operating - HIGH SPEED or LOW SPEED - or if any other function affects the flow, i.e. filter test, summer night cooling, zero calibration, calibration, external high speed, external stop, etc.

The third line indicates the type of operation selected. STOP, AUTO OP or MANUAL OP.

To change the type of operation

The MAN button sets the unit in the MANUAL OP mode. In the manual operation mode, the switching clock will not carry out any automatic switching between high and low speed operation.

The AUTO button sets the unit in the AUTOMATIC OP mode. The unit should normally operate in this mode. The integrated switching clock will then manage switching between high and low speed operation.

The STOP button shuts down the unit.

The HS-LS button is used for switching between manual high speed and manual low speed operation.

To leave the menu

Press the **INST** button, the image will then switch to a start menu (described in Section 5.3). From here, you can access the temp, flow, or switching clock menus.

The **CAL** button switches the image to the filter calibration and airflow adjustment menu group.

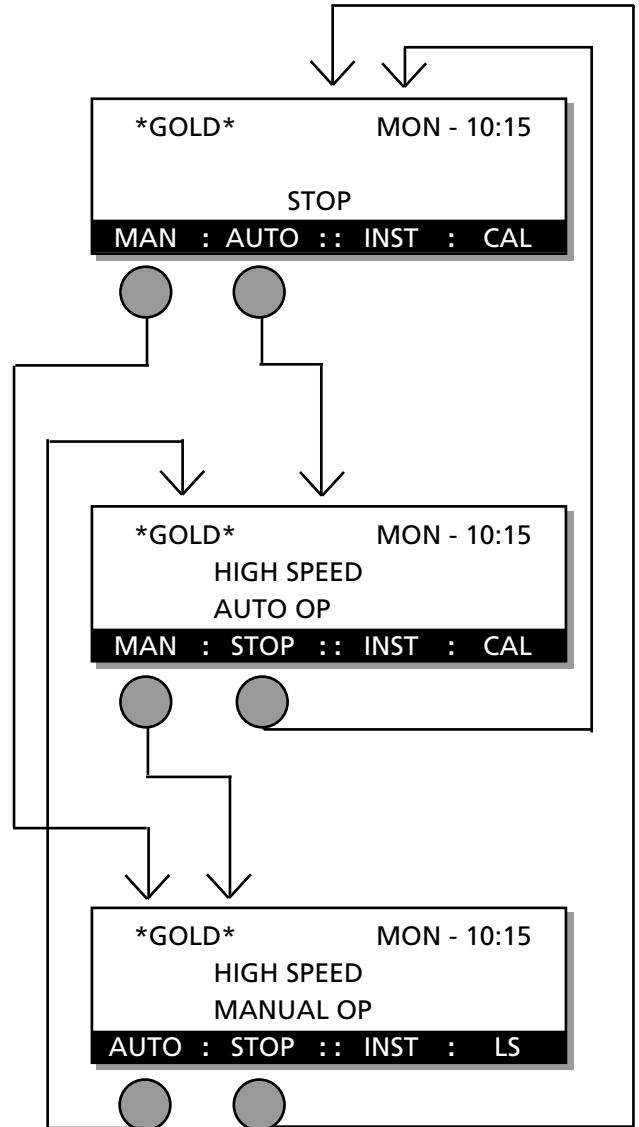

5.2 Filter Calibration and Airflow Adjustment Menu Group

This menu group can be reached by pressing the **CAL** button in the main menu as described in Section 5.1

5.2.1 Filter Calibration

An automatic filter test is activated to measure the initial pressure drop across the filters in the AHU. The filters are then continuously monitored. This filter test shall be carried out while commissioning the AHU and every time after the filters are changed.

Filter calibration is carried out as follows:

- The fans are accelerated to 75% of their preset max. speed and run at this speed for 5 minutes.
- The pressure drop across each filter is read.
- The pressure drop is stored as a reference figure for filter monitoring. Pressure drop measurements are then continually undertaken according to a rated curve.

To activate filter calibration

Press and hold the **SET** button down for 5 seconds. The function will then be activated and image will switch back to the main menu. Filter calibration is displayed alternately with selected operating mode in the menu while calibration is in progress.

5.2.2 Airflow Adjustment

The airflow adjustment function is used when it isn't desirable to allow the fans to compensate for pressure fluctuations caused by the adjustment of air devices and ducts in the ventilation system.

Whenever airflow adjustment is selected, the control locks in the current fan speed for 8 hours. After that the fans automatically return to normal operation.

To activate Air adjustment

Press the **ADJ** button to switch the image to a sub-menu where the function can be activated by pressing the **SET** button. The image will then switch back to the main menu. Air adjustment is displayed alternately with the selected operating mode in the menu.

The function can be switched off at any time by pressing the **STOP** button in the main menu.

****FILTER CALIBRATION****

CARRIED OUT ON START
AND EVERY FILTER CHANGE

ADJ : :: RET : SET

****AIRFLOW ADJUSTMENT****

LOCKS THE FAN SPEED
NB! 8 HR TIME RESTRICTION

: :: RET : SET

5.3 Start Menu for Temp, Flow and Switching Clock

The menu can be reached by pressing the INST button in the main menu. See Section 5.1.

Start Menu

This menu is used as a start menu for selecting menu groups for TEMP, FLOW or SWITCHING CLOCK. PV indicates the program version. No changes can be made in this menu.

To go on to the Temp, Flow or Switching Clock menu group

Press  button to switch the image to a menu for reading the actual (current) time and entering time channel settings. See Section 5.4.

Press the **TEMP** button to switch the image to a menu group for reading temperatures and for entering temperature settings for ERS regulation, supply air regulation or exhaust air regulation. See Section 5.5.

Press the **FLOW** button to switch the image to a menu group for reading air flows and a menu group entering flow settings. See Section 5.6.

5.1

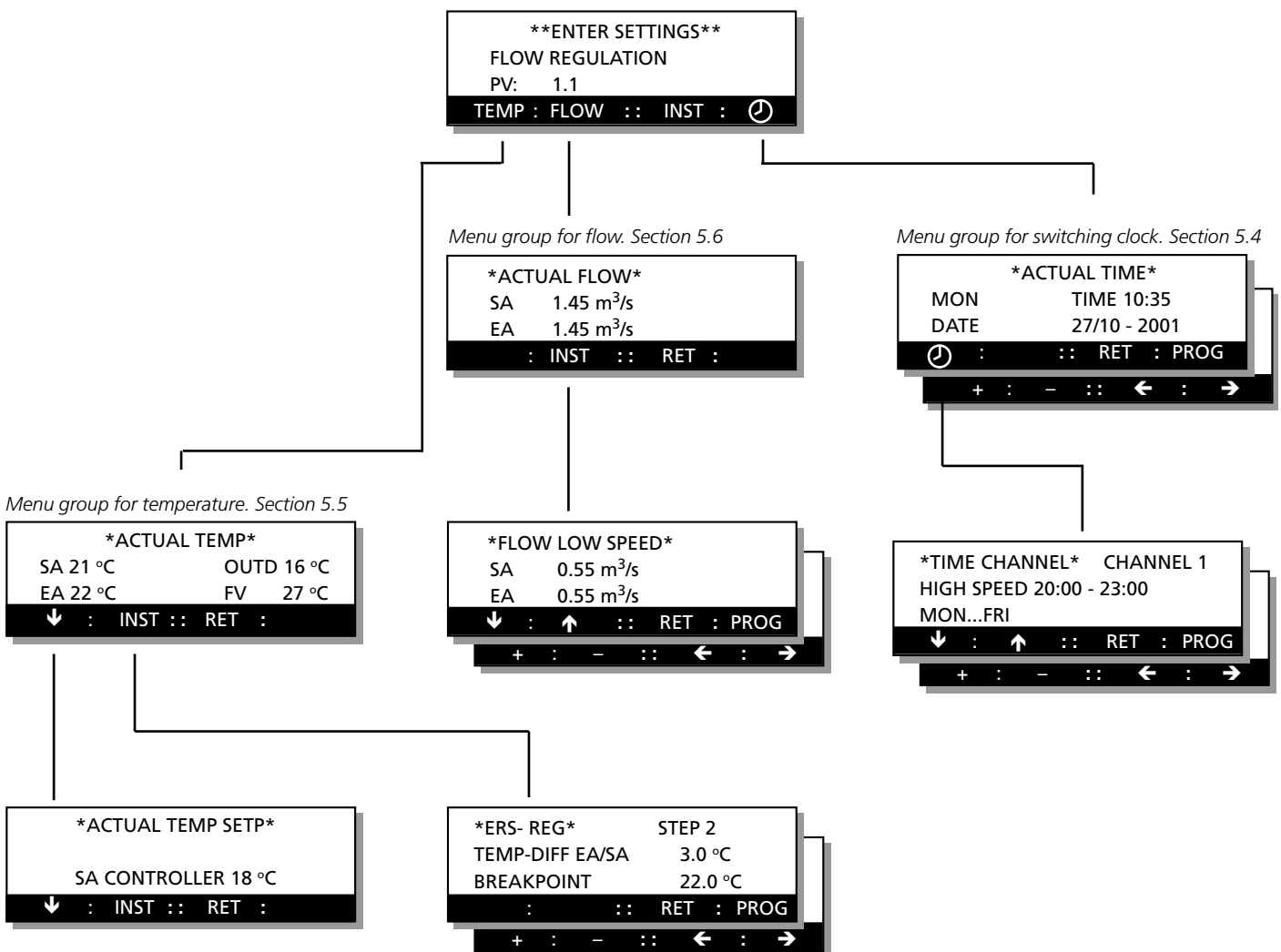

5.4 Switching Clock Menu Group

The menu group can be reached by pressing the button  in the main menu. See Section 5.3.

5.4.1 Actual Time

This menu shows the actual (current) time setting for the day of the week (MON-SON), time and date (day/month-year).

The switching clock automatically changes over from summer time to winter time and vice versa; no adjustment is necessary. See Section 6.2.8.

To change Actual Time

Press the **PROG** button to switch the image to a submenu, in which new time settings can be entered.

5.4.2 Switching Clock

This menu shows the switch-in and switch-out times of the switching clock. MON...FRE indicates the day(s), to which the times entered in the program apply.

If SWITCHED OFF is displayed, this image is not active even if switching times have already been entered in the program.

If the S-CL FUNCTION for switching between low speed - high speed operation is selected, HIGH SPEED will be displayed next to the switching times. If stop - low speed - high speed switching is selected, LOW SPEED or HIGH SPEED will be displayed. See the menu images to the right. To select whether the AHU is to operate in the mode for low speed - high speed or the low speed - high speed - stop switching, go to the S-CL FUNCTION menu, Section 6.2.4 in the Time Channel Menu Group.

To program the switching clock

Press the **PROG** button to switch the image to a submenu where the switch-in and switch-out times of the switching clock (timer) can be entered.

There are 8 programming images in which the switch-in and switch-out times as well as the day(s), to which the times shall apply, can be entered:

SWITCHED OFF

MON...FRI: means Monday to Friday.

SAT...SUN: means Saturday to Sunday

MON...SUN: means the whole week.

MON, TUE, WED, THU, FRI, SAT, SUN: denote the relevant day of the week.

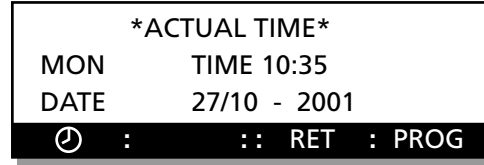

5.4.2

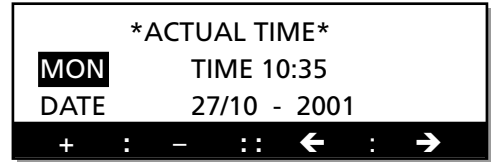

5.5 Temperature Menu Group

The menu group can be reached by pressing the TEMP button in the start menu for temp, flow and switching clock as described in Section 5.3.

5.5.1 Temperature Menus, General

The current temperatures such as the outdoor air temperature, supply air temperature and exhaust air temperature can be read in the temperature menus. If an air heater for hot water is fitted, FV in the display indicates the water temperature in the return water piping. SA CONTROLLER indicates the current set point for controlling the supply air temperature. EA CONTROLLER indicates the current set point for controlling the exhaust air temperature if EA REG has been selected.

The temperature can be regulated with any of following three separate functions; ERS regulation, supply air regulation or exhaust air regulation.

The temperature regulation function can be selected in the TEMP REG FUNCTION menu. See Section 6.2.1 in the Functions menu group.

The temperature setting for the function selected can be entered in any of the following three menus whichever is available.

5.5.2 ERS Regulation

This menu is shown only if ERS regulation has been selected as described in the Menu Section 6.2.1 in the Functions menu group.

ERS regulation stands for **Exhaust air temperature Related Supply air temperature regulation**. This involves regulating the supply air temperature in relation to the exhaust air temperature. The GOLD unit is primarily designed for operating with this type of regulation. **IMPORTANT!** If the SA flow has been preset almost as low as the min. permissible air flow of the unit, the supply air fan cannot be controlled to the minimum set point. See section 7.15.

STEP indicates the temperature curve selected. Step 1, 2, 3 or 4 can be selected by going into the chart in Fig. 3. Step 2 has been preset at the factory.

OFF/ON-DIFF is the difference between supply air temperature and exhaust air temperature below the breakpoint in the chart. The chart has been plotted for a differential of 3°C.

The BREAKPOINT is the point in the chart, from which the different steps radiate. It is defined from the exhaust air temperature. In the chart the breakpoint is 22°C.

To alter the settings

Press the **PROG** button. The image will then switch to a submenu, in which new settings can be entered.

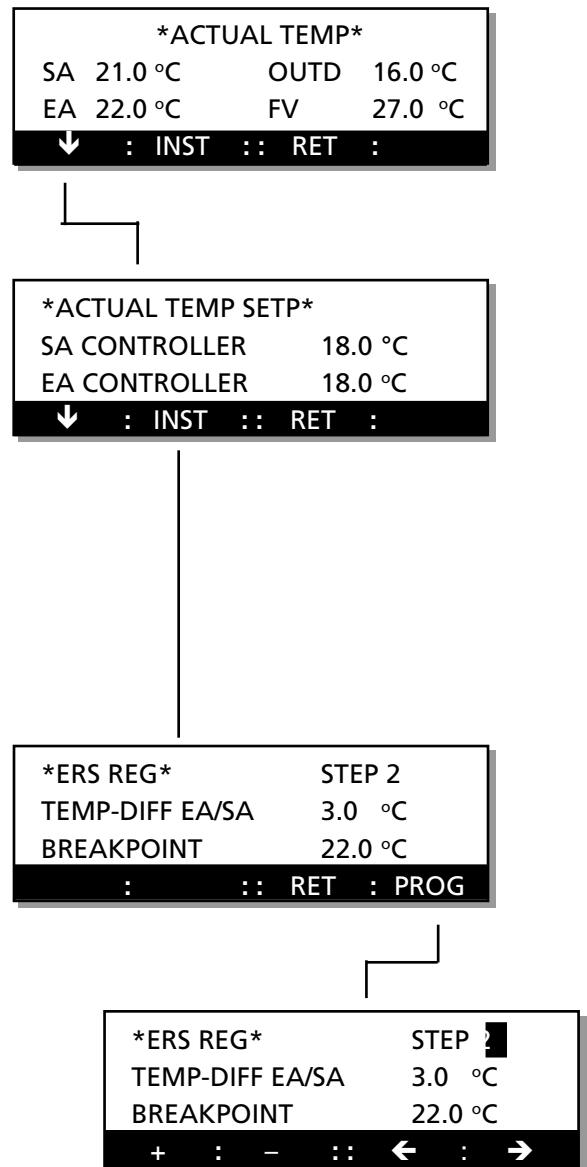
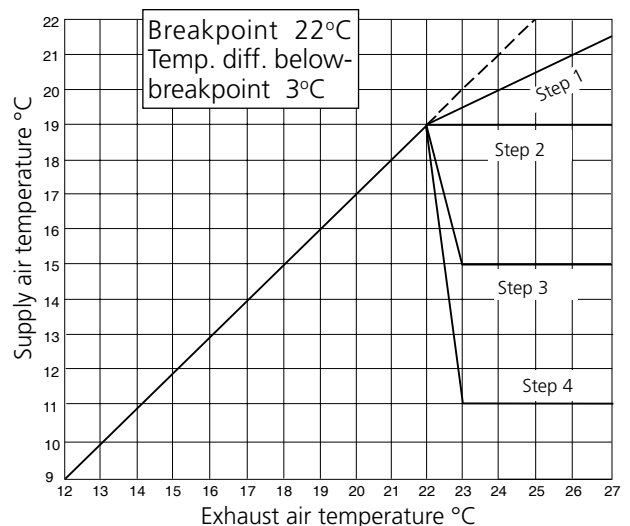

Fig 3



5.5.3 Exhaust Air Regulation

This menu is shown only if exhaust air regulation has been selected as described in the Menu Section 6.2.1 in the Functions Menu Group.

Exhaust air regulation involves maintaining a constant temperature in the exhaust air duct (premises) by raising and lowering the supply air temperature.

EXHAUST AIR TEMP indicates the temperature required in the exhaust air duct.

SA-MIN is the lowest temperature and SA-MAX is the highest temperature that the supply air is permitted to reach while the control unit is maintaining the exhaust air constant.

To alter the settings

Press the **PROG** button. The image will then switch to a submenu, in which new settings can be entered.

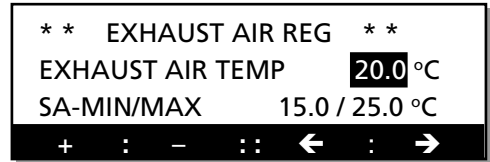
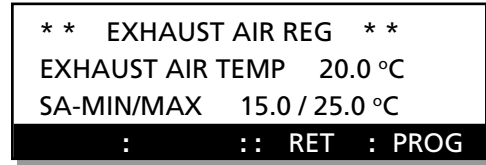

5.5.4 Supply Air Regulation

This menu is shown only if supply air regulation has been selected as described in the Menu Section 6.2.1 in the Functions Menu Group.

Supply air regulation involves maintaining a constant supply air temperature without taking the load in the premises into account.

SA TEMP indicates the temperature required in the supply air duct. IMPORTANT! If the SA flow has been preset almost as low as the min. permissible air flow of the unit, the supply air fan cannot be controlled to the minimum set point. See section 7.15.

To alter the settings

Press the **PROG** button. The image will then switch to a submenu, in which new settings can be entered.

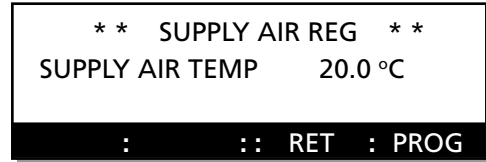

5.6 Flow Menu Group

This menu group can be reached by pressing the FLOW button in the start menu for temp, flow and switching clock.. See Section 5.3.

Size	Min. flow		Max. flow		Shortest step	
	m ³ /h	m ³ /s	m ³ /h	m ³ /s	m ³ /h	m ³ /s
GOLD 11	180	0,05	1400	0,40	50	0,01
GOLD 12	290	0,08	2200	0,62	50	0,01
GOLD 15	360	0,10	3200	0,90	50	0,01
GOLD 21	390	0,11	3950	1,10	50	0,01
GOLD 22	790	0,22	5750	1,60	50	0,01
GOLD 31	1400	0,40	10000	2,80	200	0,05
GOLD 32	2200	0,60	14000	3,90	200	0,05
GOLD 42	3000	0,80	20800	5,80	200	0,05
GOLD 52	3600	1,00	28000	7,80	200	0,05

* When setting the airflows, round off the values to the nearest possible setting.

5.6.1 Actual Air Flow

Read-only menu for reading the actual (current) supply air and exhaust air flows. Press the INST button to enter new airflow settings or to read the preset air flows at the various levels in the program.

5.6.2 Air flow - Low-speed Operation

SA shows the preset supply air flow set point.
EA shows the preset exhaust air flow set point.
m³/s shows preset airflow unit. To change to another unit of measurement, see Section 6.2.10.

To alter the settings

Press the **PROG** button. The image will then switch to a sub-menu, in which new settings can be entered.

The air flow generated when the fans are operating at low speed cannot be set higher than the air flow generated when the fans are operating at high speed.

The low-speed air flow can also be set at 0 m³/s. The fans will then be motionless during the programmed low speed period.

5.6.3 Air Flow - High Speed Operation

SA shows the preset supply air flow set point.
EA shows the preset exhaust air flow set point.

To alter the settings

Press the **PROG** button. The image will then switch to a submenu, in which new settings can be entered.

The air flow generated when the fans are operating at high speed cannot be set lower than the air flow generated when the fans are operating at low speed.

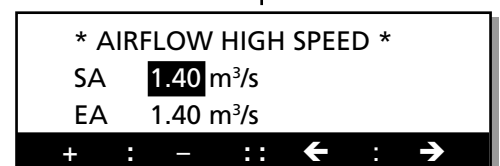
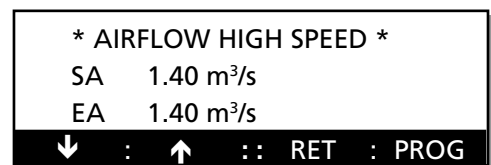
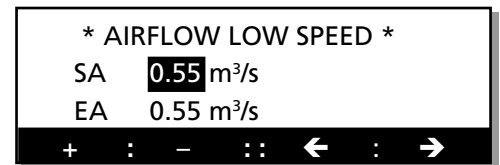
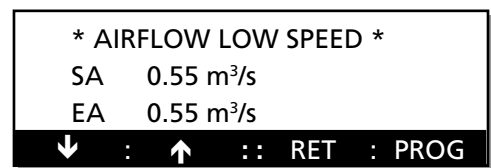
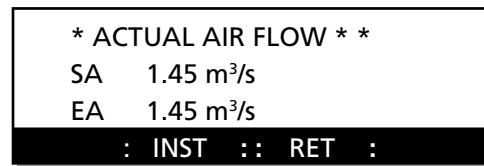

5.6.4 Air Flow - Max. Speed Operation

The menu is shown only if the VAV regulation or boosted air flow (forcing) function has been selected as described in Menu Section 6.2.2 under the Menu Group for Functions, or if the boosted (forced) cooling function has been selected in Menu Section 6.4.5 under the Cooling Menu Group.

SA indicates the preset supply air flow set point.
EA indicates the preset exhaust air flow set point.

To alter the settings

Press the **PROG** button. The image will then switch to a submenu, in which new settings can be entered. The max. air flow cannot be lower than the flow generated by the fans when they are operating at high speed.

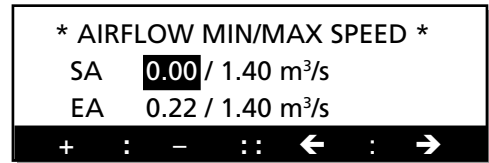
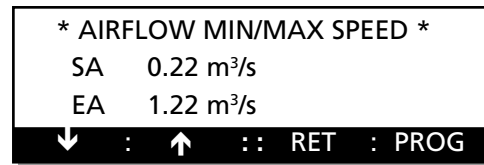
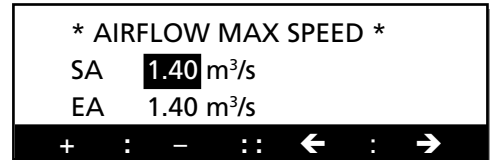
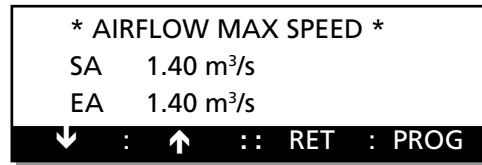

5.6.5 Air Flow Min./Max. Speed Operation

The menu is displayed only if the need for VAV regulation function has been selected in Menu 6.2.2 and 6.2.3 under the Menu Group for Functions.

SA indicates the preset min. and max. speed for supply air flow.

EA indicates the preset min. and max. speed for exhaust air flow.

To alter the settings

Press the **PROG** button. The image will then switch to a sub-menu, in which new settings can be entered. The min. air flow cannot be set at a lower setting than the permissible min. flow of the air handling unit. See the table in Section 5.6, Flow Menu Group.

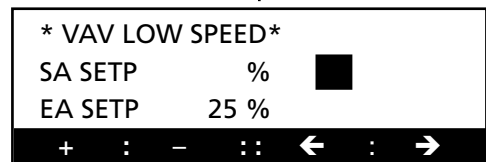
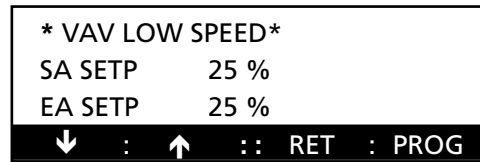

5.6.6 VAV Regulation, Set point

This menu is shown only if VAV regulation has been selected in Menu Section 6.2.2 under the Functions Menu Group.

SA SETP indicates the preset supply air set point.

EA SETP indicates the preset exhaust air set point.

This setting is entered as a percentage of the output signal (0-10 V) of the sensor fitted.

To alter the settings

Press the **PROG** button. The image will then switch to a submenu, in which new settings can be entered.
IMPORTANT! The preset max. airflow setting is the max. limit of the working range of the control unit. The preset value for VAV Low Speed cannot be higher than preset value for VAV High Speed. The preset value for VAV High Speed cannot be lower than preset value for VAV Low Speed.

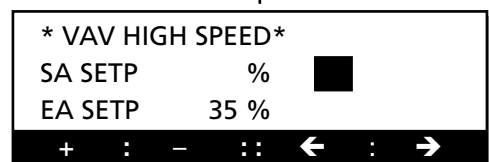
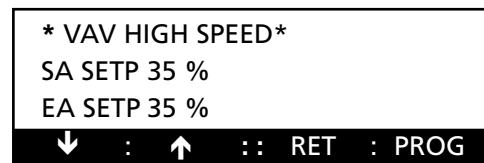

6. MENUS FOR FUNCTIONS, ENTERING ALARM SETTINGS, ENTERING COOLER SETTINGS, RUNNING MANUAL TESTS, VIEWING READINGS AND ENTERING CONTROL SETTINGS

This menu level is intended for use by qualified technicians who know the ventilation trade.

This section describes the menus that can be accessed from FUNCTION, ALARM, COOL, TEST, READ and CONTROL SETTING in the start menu.

This menu can be used for setting the various functions, entering the manual inputs and outputs, reading the operational status on all inputs, selecting the type of cooling function, etc.

CAUTION! Unless otherwise specified in the relevant menu section, the function of the menu buttons will be normal, as described in Section 4.3.

Menu Structure

Main menu, Section 5.1



Start menu for temp, flow or switching clock, Section 5.3

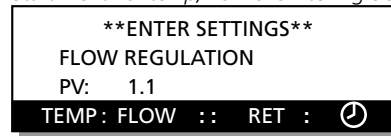

Flow menu group, Section 5.6

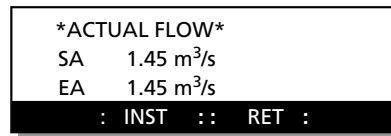

Press and hold button 4 pressed in. At the same time, press button 1 to go on to the start menu for setting functions, alarms, cooler, manual test runs, readings and setting controls.

Functions menu group, Section 6.2

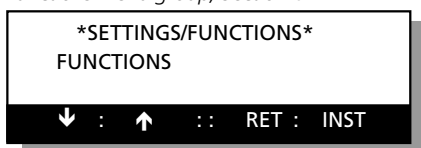

Start menu for alarm settings Section 6.3



Start menu for cooling settings Section 6.4

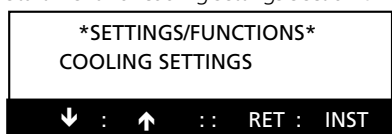

Start menu for test runs, Section 6.5

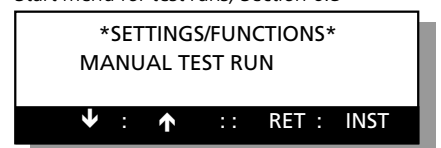

Start menu for READING settings Section 6.6



Start menu for control settings Section 6.7



6.1 Start Menu for Functions, Entering Alarm Settings, Entering Cooler Settings, Running Manual Tests, Viewing Readings and Entering Control Settings

Start menu

This menu can be reached from the Actual Flow Menu by pressing and holding button 4 and button 1 as described in Section 6. The start menu for sex different menu groups will appear. The six groups are functions, enter alarm settings, enter cooler settings, run manual test, view readings and enter control settings respectively.

To go further
Select the appropriate group for functions, enter alarm settings, enter cooler settings, run manual test, view readings and enter control settings.

Functions is a menu group used for setting the various operating modes such as summer night cooling and the control (regulation) functions. This menu group is described in Section 6.2.

Enter Alarm Settings is a menu group solely for the alarm functions. It is also possible to block or activate certain alarms. This menu group is described in Section 6.3.

Enter Cooler Settings is a menu group solely for the cooling functions. The type of cooling function and boosted cooling (forcing) can be selected here. This menu group is described in Section 6.4.

Run Manual Test is a menu group for manually entering inputs and outputs for, e.g. fans and heat exchangers. All the control functions (regulation) will be switched out while you operate the unit manually. This menu group is described in Section 6.5

View Readings is a menu group only for reading the in-operation status of the inputs, temperatures, air flows, etc. This menu group is described in Section 6.6.

Enter Control Settings is a menu group for setting the control speed and limiting temperature settings, for example. This menu group is described in Section 6.7

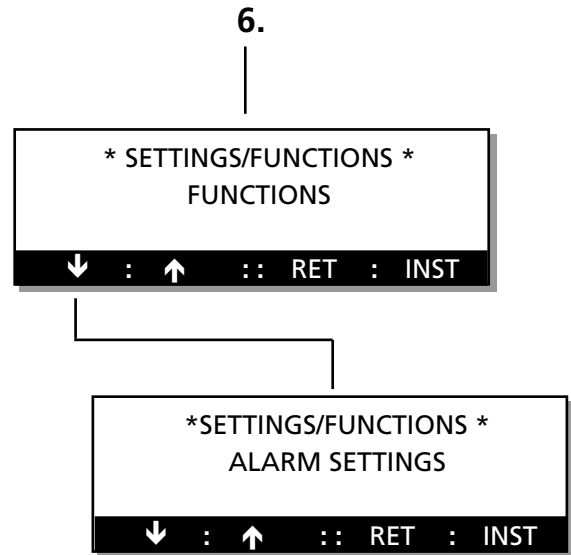

6.2 Functions Menu Group

This menu can be reached by pressing the **INST** button in the start menu for functions, enter alarm settings, enter cooler settings, run manual test, view readings and enter control settings, when **FUNCTIONS** appears in the menu image. See Section 6.1.

6.2.1 Temperature Regulation Function

The menu shows the temp. regulation function selected.

To change the regulation function
Press the **PROG** button. The image will then switch to a submenu, in which a new regulation function can be selected.

Three different types of temperature regulation can be selected; ERS Regulation, Exhaust Air Regulation and Supply Air Regulation.

Press button **1**, **2** or **3** to select one of the functions.

Then press the **SET** button to confirm the change.

The current temperature set points within the type of regulation selected can be entered under the temp. menu group as described in Section 5.5.

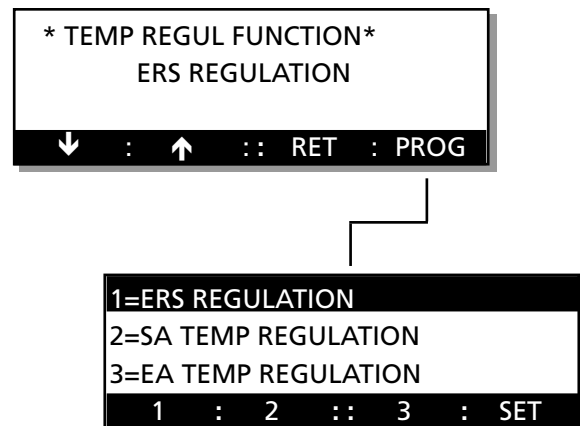

6.2.2 Fan Speed Regulation

This menu shows the function selected, according to which the fans are to be controlled. For further particulars about air flow regulation, see Section 7.12.

When AIR FLOW (normal flow regulation) is indicated, the flow is regulated so that preset value can be maintained. When the unit is set in the VAV-REGULATION mode, the fans can be controlled via a signal from an external selector switch. The unit then regulates the fan speed to maintain programmed percentages on each 0 - 10 V DC input. If the unit is operating in the boosted air flow or FORCING mode, the fans can be controlled via a signal from an external selector switch.

The speed of each fan can then be controlled in response to each 0 - 10 V DC input.

To change the type of fan regulation

Press the **PROG** button. The image will then switch to a sub-menu, in which the settings can be altered.

Three different types of regulation can be selected: Flow regulation, VAV regulation or forcing (boosted air flow).

Press button **1**, **2** or **3** to select the appropriate function.

Then press the **SET** button to confirm the change.

IMPORTANT! If VAV regulation is selected the image will switch to a sub menu for selecting VAV REG PRESSURE or VAV REG DEMAND. See Section 6.2.3.

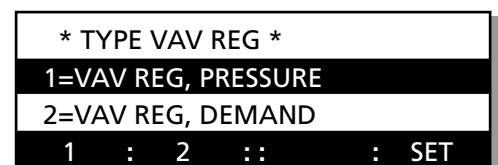

6.2.3 Type of VAV Regulation

The menu is shown only if VAV regulation has been selected in the preceding menu, Section 6.2.2.

To alter the type of regulation selected

Select the type of regulation by pressing button **1** or **2**. Then press the **SET** button to confirm your selection.

6.2.4 Time Channel Function

This menu shows the function selected for the integrated switching clock: low speed - high speed or stop - low speed - high speed operation.

LOW SPEED - HIGH SPEED indicates that the low speed - high speed unit operating mode has been selected.

STOP - LOW SPEED - HIGH SPEED indicates that the stop - low speed - high speed unit operating mode has been selected.

To alter the operating mode

Press the **PROG** button. The image will then switch to submenu where the setting can be altered.

Select the operating mode by pressing button 1 or 2.

Then press on button **SET** to confirm your new setting.

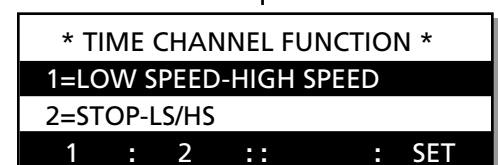
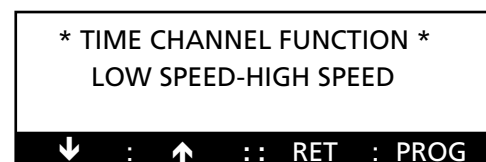

6.2.5 Summer Night Cooling

The digit to the right of the SUMMER NIGHT COOLING caption indicates whether the function has been selected. To enable and set starting times and temperatures; press PROG, select SUMMER NIGHT COOLING = 1. Then press the INST button to advance to the next menu.

- Value 1 = On (function selected).
- Value 0 = Off (function not selected).

The summer night cooling START TIME can be set between 00 and 0659 hours. EA denotes the minimum exhaust air temperature required for the function to switch in. OUTDOOR denotes the minimum outdoor air temperature required for enabling the function. STOP EA denotes the exhaust air temperature at which summer night cooling operation will switch out. For detailed particulars of summer night cooling, see Section 7.6.

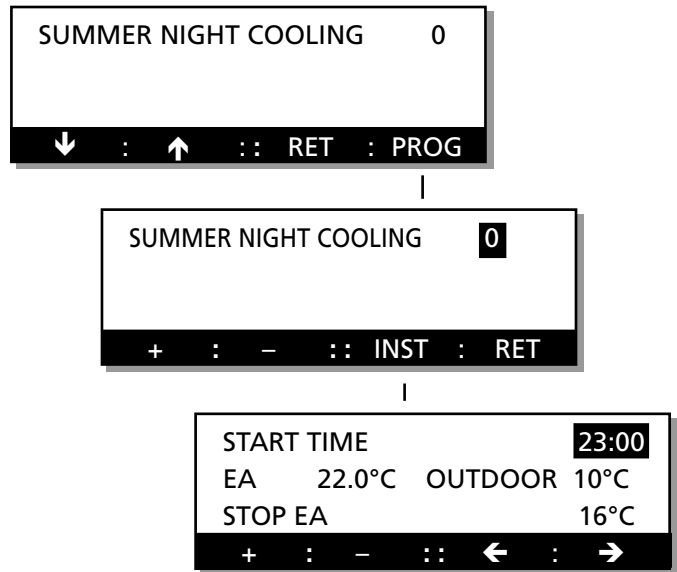

6.2.6 Outdoor Temperature Compensation

Outdoor air temperature compensation involves using the outdoor air temperature for altering the supply air or exhaust air temperature set point. The supply air temperature set point and the exhaust air temperature set point will be influenced by supply air or exhaust air temperature regulation respectively. The temperature set point will be influenced if the outdoor air temperature drops below +10°C as indicated in the winter compensation curve and if it rises above +25°C as indicated in the summer compensation curve. See chart in Fig 4. If ERS regulation is utilized, it will override this function. Negative summer compensation can also be preset. The upper right-hand digit in the menu indicates whether any of the outdoor air temperature compensation functions has been selected.

- Value 1 = On (function selected).
- Value 0 = Off (function not selected).

OUTDOOR TEMPERATURE-COMP indicates whether the function has been selected. To enable and set the values, press PROG, select OUTDOOR TEMP COMP = 1. Then press the INST button to advance one step to the next menu. WINTER COMP denotes the temperature displacement that the breakpoint has at -20°C. Adjustable between 0 °C - +10 °C. SUMMER COMP denotes the temperature displacement that the breakpoint has at +40°C. Adjustable between -10 °C - +10 °C. FLOW COMP is the airflow/VAV set point to which the fans are decelerated when the temperature drops to -20 °C. Adjustable: 0–50%. The breakpoints for winter, summer- and flow compensation can be adjusted under the Control Setting Menu Group described in Sections 6.7.3 and 6.7.4.

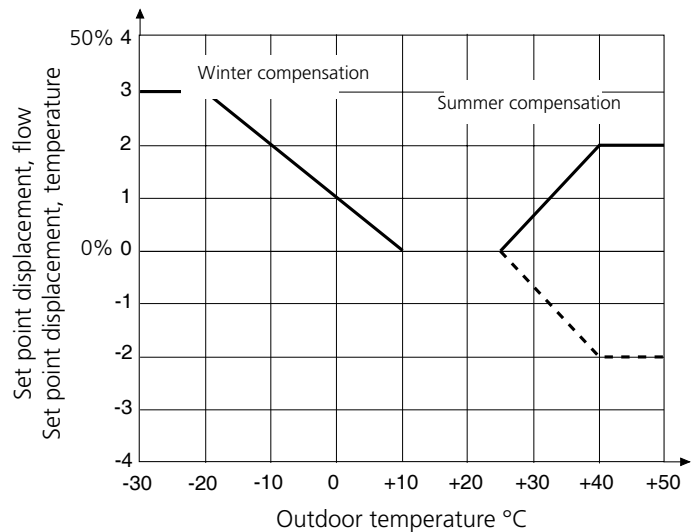
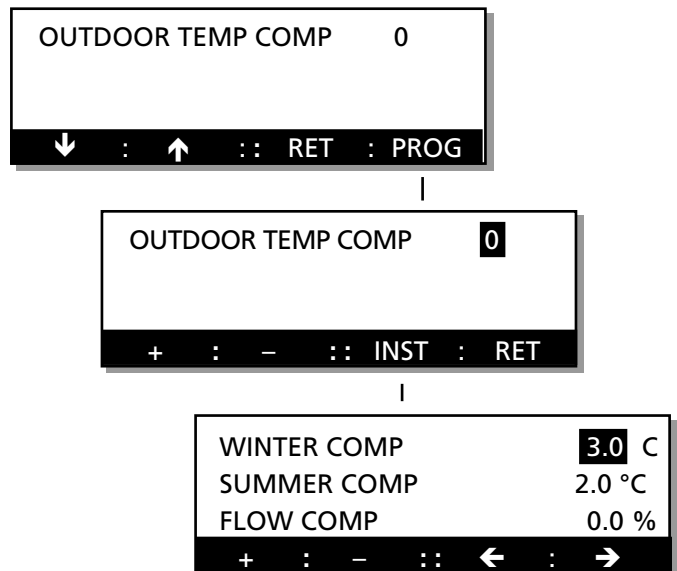

Fig 4



6.2.7 External LS/HS Time Delay

This menu shows time delay for externally switched low speed/high speed operation.

To alter the settings

Press the **PROG** button. The image will then switch to a submenu, in which the settings indicating the functions selected can be altered.
 EXT LS/HS TIME DELAY delays return to stop or low speed operation when the input for external switching alternates between high speed and low speed. A typical application is prolonged operation, keyed in from a terminal.
 The in-operation period can be set from 0:00 to 23:59; (hours and min.). If the time is 0:00 hours, the function won't be activated.

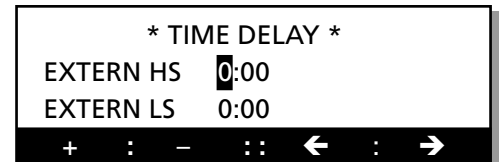
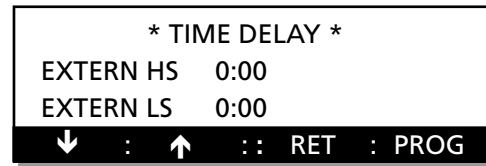

6.2.8 Set Point Displacement and Automatic Changeover from Summer Time to Winter Time and vice versa

SET POINT DISP indicates whether the function has been selected. For more details, see Section 7.7.
 AUTO CHANGEOVER SUM/WIN is shown if the function for automatic changeover from summer time to winter time and vice versa by the switching clock has been selected.

To alter the settings

Press the **PROG** button. The image will then switch to a submenu, in which the setting for the functions selected can be altered.



6.2.9 Circulation Pump for the Hot Water Circuit

PUMP FUNCTION is shown if the function for the pump output has been selected.
 If this function is selected, the pump output contacts will close if heating is necessary. Whenever the outdoor temperature is low (below +12 °C) the pump output contacts will be continuously closed.
 EXERCISE PUMP is shown if exercise operation has been selected for the pump outlet.
 If this function is selected, the pump output contacts will be closed for 1 minute to intermittently operate the pump every 24 hours.

To alter the settings

Press the **PROG** button. The image will then switch to a submenu, in which the setting for the functions selected can be altered.

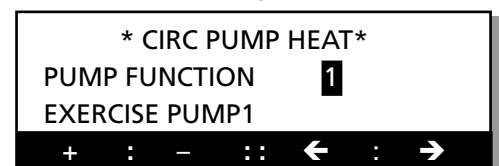
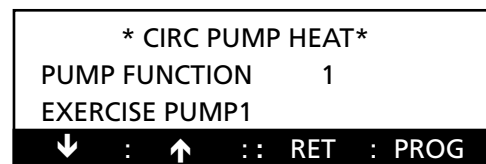

6.2.10 To Change the Flow Unit

This menu indicates the preset unit of measurement for air flows.

To alter the setting

Press the **PROG** button. The image will then switch to a submenu, in which the setting can be altered.

Press button **1** or **2** to select m³/h or m³/s as the unit of measurement for air flows. Then press the **SET** button to confirm the new setting.

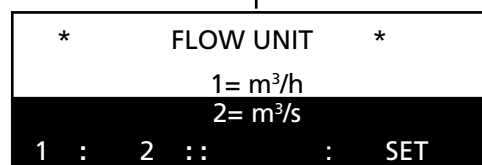
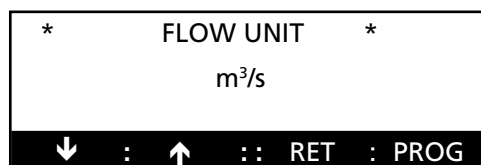

6.2.11 Language

This menu indicates the languages available. This setting can be altered at any time to a different language.

To change language in the display

Press the **PROG** button to switch the display over to a submenu, in which the language can be altered.

Select the language by pressing the arrow buttons to advance upward or downward through the images.

Then press the **SET** button to confirm your change.

The control unit will begin changing the language in the display after you return to the main menu.

The new language will be displayed after a delay of 40 seconds



6.3 Alarm Menu Group

6.3.1 Service alarm

This menu can be reached from the start menu for functions, entering alarm settings, entering cooler settings, running manual tests, viewing readings and entering control settings by pressing the INST button when the menu image shows ENTER ALARM SETTINGS, see section 6.1. SERV PERIOD indicates how many months are left until the service period exceeded alarm will trip. This alarm can be reset by programming a number of months for the next service interval.

To alter the setting

Press the **PROG** button. The image will then switch to a submenu, in which the setting for the functions selected can be altered.

6.3.2 Filter Alarm Limit

SA FILTER indicates the degree of contamination in the supply air filter that will trip the alarm. EA FILTER indicates the degree of contamination in the exhaust air that will trip the alarm.

To alter the filter alarm limit

Press the **PROG** button to change the display over to a submenu, in which a new filter alarm limit setting can be entered.

As contaminants are gradually collected the filter, the pressure drop increases correspondingly. When the pressure drop exceeds the alarm limit, an alarm is initiated. The limit can be set from 0 to 99. The factory setting, 10, corresponds to the recommended final pressure drop of the filter.

If this limit setting is exceeded, the alarm is tripped. Whenever an alarm is initiated, the LED on the hand-held terminal will flash and the display will indicate in clear text which filter is fouled (dirty).

6.3.3 Temperature Alarm Limit

MIN. EXHAUST AIR is the min. permissible exhaust air temperature before an alarm will be initiated and the unit will be stopped.

TEMP BELOW SA SETP indicates how much the supply air temperature is permitted to be below the supply air temperature set point before an alarm will be initiated and the unit will be stopped.

To alter the temperature alarm limit

Press the **PROG** button to change the display over to a submenu, in which a new temperature alarm limit setting can be entered.

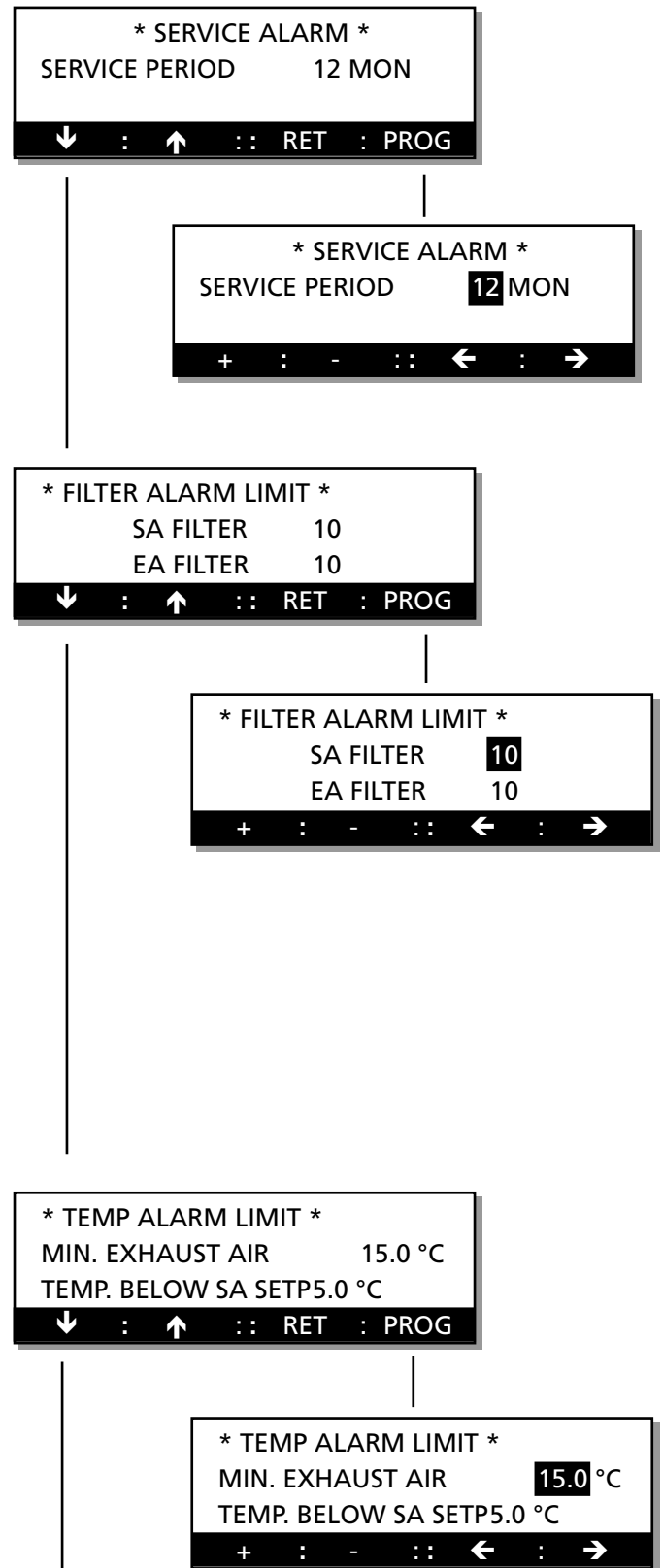

Contd. on next page.

6.3.4 Internal Fire Protection

INTERNAL FIRE PROTECTION indicates whether the function is activated (= 1) or not activated (= 0).
EA IN EVENT OF FIRE indicates whether the function is activated (= 1) or not activated (= 0).

If the internal fire protection is activated:

If the supply air temperature exceeds 70 °C or if the exhaust air temperature exceeds 50 °C, the "INT FIRE ALARM TRIPPED" alarm text will be displayed and the control unit will stop the AHU.

If the exhaust air in the event of fire is activated:

If this function is activated and the internal or external fire alarm is tripped, the exhaust air fan will accelerate to max. speed to operate as a smoke extraction fan and the relay for damper control will be energised,

To alter the settings

Press the **PROG** button. The image will then switch to a submenu, in which the setting for the functions selected can be altered.

Contd. from the preceding page.

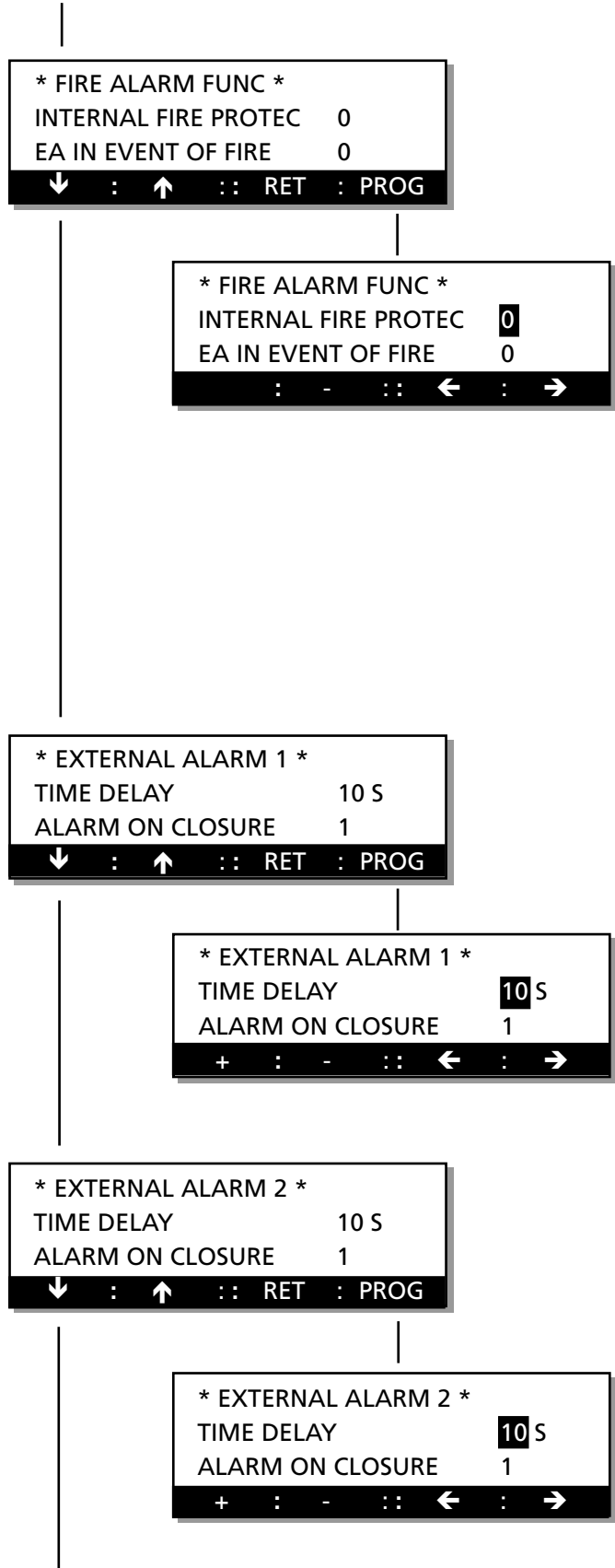

Contd. on next page.

6.3.6 Alarm Settings

The priority settings of all the alarms can be read and most of the alarms can also be set in this menu.

NO indicates the alarm number setting.

PRIORITY indicates whether alarm relay 1/A or 2/B has been selected for the current alarm. 0 = the alarm has been blocked.

ALARM IND indicates whether or not the alarm-indicating lamp in the display shall indicate alarms. 1 = alarm indication can be viewed; 0 = blocked alarm indication.

STOP indicates whether the AHU is to be stopped when the current alarm trips. 1 denotes stop, 0 denotes that the AHU will continue to operate.

To alter the settings

Press the **PROG** button. The image will then switch to a submenu, in which the current alarm for reading/change can be altered. Then press the **SET** button to alter the settings.

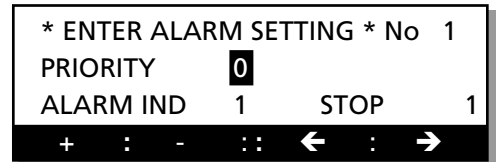
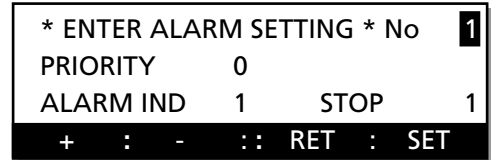
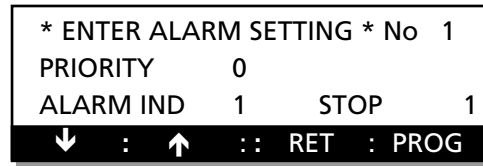

6.4 Cooling Menu Group

This menu can be reached from the start menu for functions, entering alarm settings, entering cooler settings, running manual tests, viewing readings and entering control settings by pressing the INST button when the menu image shows COOLING

SETTINGS as described in Section 6.1.

The menus are used for setting the cooling functions.

6.4.1 Cooling Function

The menu indicates which cooling function is selected.

To alter the cooling function

Press the PROG button. The image will then switch to a submenu, in which the cooling function can be activated.

To leave the menu

Other buttons for the menu have a normal function.

To choose Cooling Operation Option

STOP, OPERATION or another CHOOSE COOL FUNC can be selected in the submenu.

Choose the appropriate option: **1**, **2** or **3**. Then press the SET button to confirm the change.

If you select option 1=STOP or 2=OPERATION, the image will switch back to the previous menu.

If you select option 3=CHOOSE COOL FUNC, the image will switch to another submenu where the type of cooling function can be changed.

To choose Cooling Function Option

Press button **1** or **2** to choose the appropriate option. Then press the SET button to confirm the change.

If you select option 1 = cooling 0-10 V, the image will switch back to " COOLING MACHINE REG".

If you select option 2 = cooling on/off, the image will switch to yet another submenu containing a level for changing the type of on/off function.

To choose cooling on/off function

Press button **1**, **2** or **3** to choose the appropriate option. Then press the SET button to confirm the change.

If you select COOLING 0 - 10 V, cooling relay 1 is energized when cooling is needed and the 0 - 10 V DC output signal is modulated in relation to the current cooling load.

If you select COOLING ON/OFF, only the cooling relay will function. The relay is energized when the need for cooling arises and is de-energized when the room air or supply air temperature has dropped below the set point + neutral zone, or if the SA temp. drops below the minimum limit.

If you select COOLING ON/OFF 1-STAGE, cooling relay 1 is energized if cooling is required.

If you select COOLING ON/OFF 2-STAGE, cooling relays 1 and 2 are energized in sequence.

If you select COOLING ON/OFF 3-S-BIN, cooling relays 1 and 2 will be energized as a binary action.

Each cooling stage has a permanent time delay of 60 seconds between it and the next stage as they are switched in and switched out.

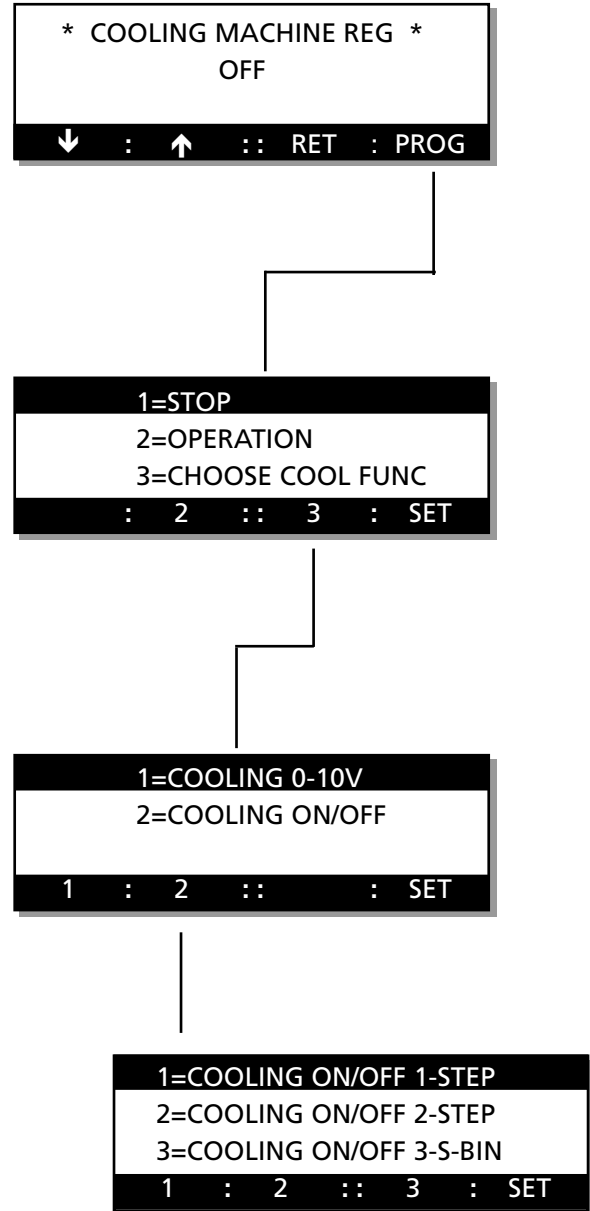

6.4.2 Circulation pump, cooling circuit

If COOLING RELAY 1 or 2 is used to operate pumps or the like, whenever there is a need to exercise the pumps (periodically, briefly start up the pumps), this mode can be selected.

1 = the pump exercise mode is activated.

If the function is activated, the pump will be exercised for 1 minute once every 24 hours.

To alter the settings

Press the **PROG** button. The image will then switch to a submenu, in which new settings can be entered.

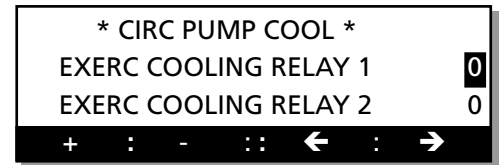

6.4.3 Outdoor temperature limit for cooling

If COOLING ON/OFF has been selected, it is possible to set an outdoor temperature limit for when the cooling output stages will be switched in. Every cooling output stage has a separate lowest permissible outdoor temperature setting for switching in.

To alter the settings

Press the **PROG** button. The image will then switch to a submenu, in which new settings can be entered.

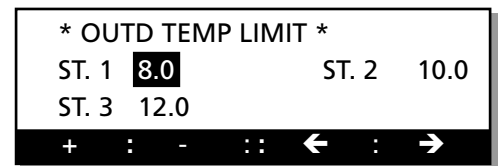
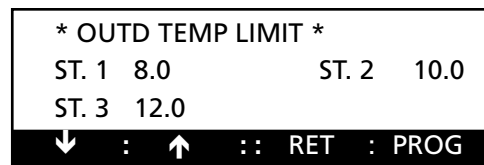

6.4.4 Re-starting Time. Neutral Zone

RE-START TIME is the period from when cooling relay 1 has been energized until when it can be energized again. The purpose of this time delay is e.g. to prevent the cooling machine from being uninterruptedly switched in and out.

The NEUTRAL ZONE is the temperature range between which the set point for cooling is higher than the set point for heating.

To change adjustment

Press the **PROG** button. The image will then switch to a submenu, in which new settings can be entered.

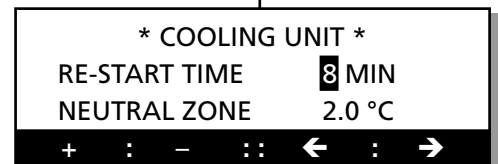
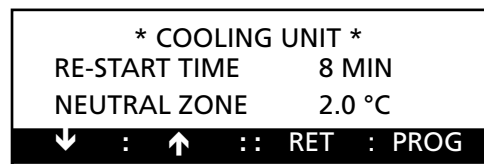

6.4.5 Boosted Cooling

COOLFORCING (boosted cooling) indicates which one of the boosted cooling options listed below is activated:

- 1 = No boosted cooling
 - 2 = Boosted cooling - comfort (the output of the cooling unit will be boosted before the air flow is boosted)
 - 3 = Boosted cooling - economy setting (air flow will be boosted before the output of the cooling unit is boosted)
- The function can only be used when exhaust air temperature regulation is employed.

The current air flow will be increased to the preset max. air flow rate. If boosted cooling has been activated, the AIR-FLOW MAX SPEED setting will be available under FLOW. When the function switches in, COOLFORCING flashes alternately with the ordinary text in the display (not visible in all the program versions).

It is also possible to read when the function switches in and the percentage of increasing airflow from the menu group for Control Sequence Temperature readings (see Section 6.6.5).

Boosted Cooling - Comfort Setting

If cooling is needed, the output to the cooling unit will be activated.

As the supply air temperature approaches the preset SA-MIN temperature, the flow rate will increase to transport more cooling energy without dropping below the min. permissible temperature.

If the cooling load is modest, the airflow will first be reduced to the normal rate.

Boosted Cooling - Economy Setting

If the cooling is needed, the air flow will slowly increase up to the preset FLOW MAX SPEED rate.

If the air flow rate is at max. and yet more cooling is required, the outputs to the cooling unit will be activated.

6.4.6 Cooling min. flow

COOL MIN FLOW indicates the preset min. supply air and exhaust air flow rates respectively required for transmission of an output signal to start the cooling unit.

When this function is activated, the cooling function will be blocked if the air flow is less than the preset airflow rates.

To alter the settings

Press the **PROG** button. The image will then switch to a submenu, in which new settings can be entered.

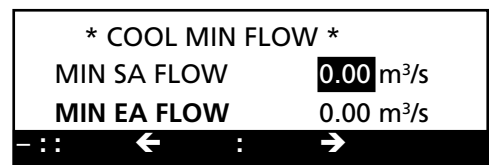
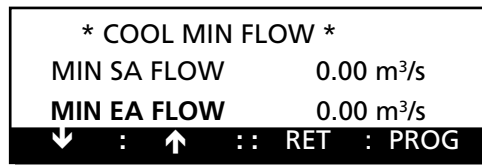

6.5 Manual Test Menu Group

This menu can be reached from the start menu for functions, entering alarm settings, entering cooler settings, running manual tests, viewing readings and entering control settings by pressing the INST button when the menu image shows MANUAL TEST MODE as described in Section 6.1.

The menu group contains menus for manual operation from the hand-held terminal and test functions outside the normal regulation functions to facilitate checks and fault tracing. When TEST is activated, all the control functions are disabled. All outputs are controlled manually.

IMPORTANT! The responsibility for any discomfort caused unusual airflow or temperature conditions rests wholly on the person who has activated the function.

To single step between the menus

Press the \downarrow button to go on to the next menu, or press the \uparrow button to go back to the previous menu.

6.5.1 SA Flow/Motor Speed

S-AIR FLOW shows the preset supply air flow.

FLOW-SIGNAL shows the pressure sensed by the SA pressure transducer (air flow meter).

MOTOR shows the modulation as a percentage that the frequency converter calls for to maintain the preset air flow.

ALARM shows whether or not the frequency converter indicates for any alarm function.

To alter the SA Flow

Press the **PROG** button and press the \leftarrow or \rightarrow button to advance to the function to be changed.

Then press the + or - button to alter the value.

SA SPEED indicates the set fan speed in % of the speed range of the fan.

FLOW PRESSURE, MOTOR and ALARM indicate values according to the above.

To alter the SA fan speed

This can be carried out in the programming menu for SA flow. Press the + and - buttons at the same time. The menu image will then change to SA SPEED. Then press the + or - button to alter the value.

To return to SA flow

Press the + and - buttons at the same time. The menu image will then change to SA FLOW.

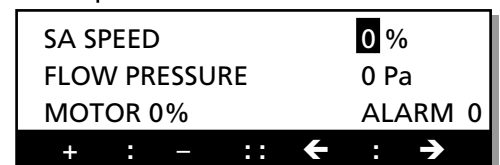
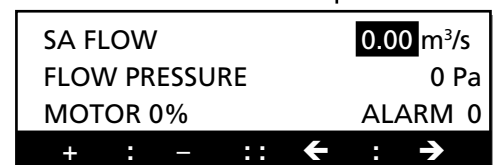
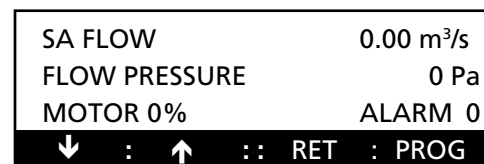

6.5.2 EA Flow/EA Speed

E-AIR FLOW shows the preset exhaust air flow.
 FLOW-SIGNAL shows the pressure sensed by the EA pressure transducer (the air flow meter).
 MOTOR shows the modulation as a percentage that the frequency converter calls for to maintain the preset air flow.
 ALARM indicates whether or not the frequency converter indicates for any alarm function.

To alter the EA Flow

Press the **PROG** button and press the **←** or **→** button to advance to the function to be changed.
 Then press the **+** or **-** button to alter the value.
 EA SPEED indicates the preset fan speed in % of the speed range of the fan.
 FLOW PRESSURE, MOTOR and ALARM indicate values according to the above.

To alter the supply air fan speed

This can be carried out in the programming menu for EA flow. Press the **+** and **-** buttons at the same time. The menu image will then change to EA SPEED. Then press the **+** or **-** on button to alter the value.

To return to EA Flow

Press the **+** and **-** buttons at the same time. The menu image will then change to EA FLOW.

EA FLOW	0.00 m ³ /s
FLOW PRESSURE	0 Pa
MOTOR 0%	ALARM 0
↓ : ↑ :: RET : PROG	

EA FLOW	0.00 m ³ /s
FLOW PRESSURE	0 Pa
MOTOR 0%	ALARM 0
+ : - :: ← : →	

FL VARVTAL	0 %
FLOW PRESSURE	0 Pa
MOTOR 0%	ALARM 0
+ : - :: ← : →	

6.5.3 Heat Exchanger Rotor

H EXCH ROTOR shows the rotor speed required.
 For size 11-12 GOLD units, 0 - 12 rpm.
 For size 15 GOLD units, 0 - 11 rpm.
 For size 21-22 GOLD units, 0 - 8 rpm.
 For size 31-32 GOLD units, 0 - 6 rpm.
 For size 42 GOLD units, 0 - 7 rpm.
 For size 52 GOLD units, 0 - 6 rpm.
 PULSE ROT SENSOR indicates the status of the rotation detector.
 MOTOR indicates the modulation in % required by the control unit for maintaining the preset speed of rotation.
 ALARM indicates a possible alarm from the heat exchanger controller.

To alter the preset value

Press the **PROG** button and press the **←** or **→** button to advance to the function to be changed.
 Then press the **+** or **-** button to alter the value.

H EXCH SPEED	0 rpm
PULSE ROT SENSOR	0
MOTOR 0%	ALARM 0
↓ : ↑ :: RET : PROG	

H EXCH SPEED	0 rpm
PULSE ROT SENSOR	0
MOTOR 0%	ALARM 0
+ : - :: ← : →	

6.5.4 Reheating

REHEATING shows the setting for the 0-10 V DC output.
HEAT RELAY shows the setting for relay output.
Value 1 = On (closed output).
Value 0 = Off (open output).

To alter the preset value

Press the **PROG** button and press the **←** or **→** button to advance to the function that is to be changed.
Then press the **+** or **-** button to alter the value.

REHEATING	0 V
HEAT RELAY	0
↓ : ↑ :: RET : PROG	

REHEATING	0 V
HEAT RELAY	0
+ : - :: ← : →	

6.5.5 Cooling

COOL REG SIGNAL indicates the setting for the 0-10 V DC output.
COOLING RELAY 1 and COOLING RELAY 2 respectively indicates the setting for each relay output.
Value 1 = On (closed output).
Value 0 = Off (open output).

To alter the preset value

Press the **PROG** button and then press the **←** or **→** button to advance to function that is to be altered.
Then press the **+** or **-** button to alter the value.

COOL REG SIGNAL	0 V
COOL RELAY 1	0
COOL RELAY 2	0
↓ : ↑ :: RET : PROG	

COOL REG SIGNAL	0 V
COOL RELAY 1	0
COOL RELAY 2	0
+ : - :: ← : →	

6.5.6 Group Alarm, In-operation Indication and High Speed Output

GROUP ALARM shows the setting for each relay output.
IN-OP IND/DAMPER and HS INDICATION respectively shows the setting for each relay output.
Value 1 = On (closed output).
Value 0 = Off (open output).

To alter the preset value

Press the **PROG** button and then press the **←** or **→** button to advance to function that is to be altered.
Then press the **+** or **-** button to alter the value.

GROUP ALARM	A0	B0
IN-OP IND/DAMPER	0	
HS INDICATION	0	
↓ : ↑ :: RET : PROG		

GROUP ALARM	A0	B0
IN-OP IND/DAMPER	0	
HS INDICATION	0	
+ : - :: ← : →		

6.5.7 Current Temperature, Read-only Menu

The menu is for viewing the readings only.
SA indicates the current supply air temperature.
OUTD indicates the current outdoor air temperature.
EA indicates the current exhaust air temperature.
FV indicates current temperature setting on the anti-frosting monitor, if one is connected.

*	CURRENT TEMP		*
SA	20.0°C	OUTD	10.0°C
EA	22.0°C	FV	15.0°C
↓ : ↑ :: RET :			

6.6 Read-only Menu Group

This menu can be reached from the start menu for functions, entering alarm settings, entering cooler settings, running manual tests, viewing readings and entering control settings by pressing the INST button when the menu image shows READING as described in Section 6.1.

No settings can be altered in the Read-only Menu Group. This menu group only indicates current status on various values.

To single step between the menus

Press the ↓ button to go on to the next menu, or press the ↑ button to go back to the previous menu.

6.6.1 Current temperature

SA indicates the current supply air temperature.
 OUTD indicates the current outdoor air temperature.
 EA indicates the current exhaust air temperature.
 FV indicates current temperature setting on the anti-frosting monitor, if one is connected.

* CURRENT TEMP *			
SA	21 °C	OUTD	16.3 °C
EA	22.5 °C	FV	28.3 °C
↓	:	↑	:: RET :

6.6.2 Current temperature set point

SA CONTROL indicates the current set point for the control in the supply air.
 EA CONTROL indicates the current set point for the control in the exhaust air (this parameter is indicated only when EA REG is selected).

* CURRENT TEMP SETP *	
SA CONTROL	21.5 °C
EA CONTROL	22.5 °C
↓	: ↑ :: RET :

6.6.3 Current flow

SA indicates the current supply air flow.
 EA indicates the current exhaust air flow.

* CURRENT FLOW *	
SA	1.00 m³/s
EA	1.00 m³/s
↓	: ↑ :: RET :

6.6.4 Current flow set point

SA indicates the current SA flow set point, for control in the supply air.
 EA indicates the current EA flow set point, for control in the exhaust air.

* CURRENT FLOW SETP *	
SA	0.90 m³/s
EA	0.90 m³/s
↓	: ↑ :: RET :

6.6.5 Control sequence temperature

If the COOLFORCING function is active, this reading indicates the current level at which the fans are generating a boosted air flow.
 COOL C1 and C2 indicate whether each relay output for cooling is on (1) or off (0).
 The last percentage indicates the status on cooling output: 0-10 V.
 HEAT EXCH indicates at which level the rotor is operating.
 REHEATING indicates the current output signal to the reheating coil.
 V1 indicates if relay output for heat is on (1) or off (0).
 REG TO MIN SETP indicates how much the supply air fan is controlled down to the minimum set point.

* CONT SEQUENCE TEMP *		
COOLFORCING		0%
COOL C1	0	C2 0 0%
↓	:	↑ :: RET :

HEAT EXCH		100%
REHEAT	V1	0%
REG TO MIN SETP	SA	22%
↓	:	↑ :: RET :

6.6.6 Supply air, exhaust air fan

SA FAN SIGNAL indicates at which level the supply air fan is operating.

FREQUENCY MOTOR indicates the current modulated frequency to the supply air motor.

FLOW PRESSURE indicates the current pressure measured in the fan input.

EA FAN SIGNAL indicates at which level the exhaust air fan is operating.

FREQUENCY MOTOR indicates the current modulated frequency to the exhaust air motor.

FLOW PRESSURE indicates the current pressure measured in the fan inlet.

SA FAN SIGNAL	50%
FREQUENCY MOTOR	41 Hz
FLOW PRESSURE	1549 Pa
↓	: ↑ :: RET :

EA FAN SIGNAL	50%
FREQUENCY MOTOR	41 Hz
FLOW PRESSURE	1549 Pa
↓	: ↑ :: RET :

6.6.7 Heat exchanger

H EXCH MOTOR SIGNAL indicates at which level the rotor is operating.

PULSE ROT SENS indicates a 1 each time the rotation detector senses a magnetic pulse from the rotating rotor.

H EXCH MOTOR SIGNAL	100%
PULSE ROT SENS	0
↓	: ↑ :: RET :

6.6.8 Status inputs

FLOW REG SA and FLOW REG EA indicate the current signal from the VAV/Forcing (boosted airflow) input respectively.

(0-100 % = 0-10 V).

SETP DISPLACEMENT indicates the current input signal from the input to temperature set point displacement (0-100 % = 0-10 V).

EXT STOP indicates status on that input (1 = closed input, 0=open input).

FIRE indicates status on that input (1 = closed input, 0 = open input).

EXT HS indicates status on that input (1 = closed input, 0 = open input).

R TIME indicates the remaining time before high speed (HS) switches over to low speed or stop, if a time delay is preset.

EXT LS indicates status on input (1 = closed input, 0 = open input).

R TIME indicates the remaining time before low speed (LS) switches over to stop if a time delay is preset and active.

EXT ALARM 1 and 2 indicate status on respective input (1 = closed input, 0 = open input).

TYPE REHEAT indicates value 1-10, depending on what kind/type of air heater is connected.

0 indicates that no coil is connected.

1-7 indicates type of electric air heater.

8 indicates control of multi-function coils.

9 indicates control of coil without anti-freeze guard or overheating function.

10 indicates that an air heater for water is connected.

* STATUS INPUTS *	
FLOW REG SA	12%
FLOW REG EA	20%
↓	: ↑ :: RET :

SETP DISPLACEMENT	67%		
EXT STOP	1	FIRE	1
EXT HS	0	R-TID	01:29
↓	: ↑ :: RET :		

EXT LS	0	R-TID	0:00
EXT ALARM	1/2		0/0
TYPE REHEAT			3
↓	: ↑ :: RET :		

6.6.9 Status filter

SA indicates current pressure across the supply air filter.

EA indicates current pressure across the exhaust air filter.

A L. indicates preset alarm limit in Pa at the current flow.

* STATUS FILTER *			
SA	0 PA	A L	0 Pa
EA	0 PA	A L	0 Pa
↓	: ↑ :: RET :		

6.6.10 Quick alarm reading

QUICK ALARM READING indicates an active alarm, which has not tripped because of a preset time delay.



6.6.11 Alarm history

ALARM HISTORY indicates the four most recent alarms that have tripped. A1-A4 are the numbers of the four most recent alarms, the dates and times when they tripped are also displayed.

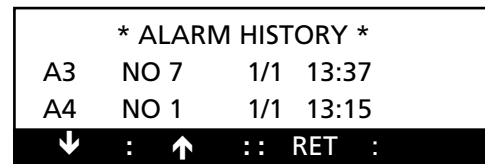

6.6.12 Unit operation

FAN indicates the airflow direction selected through the unit. OPER TIME indicates how many 24-hour days the unit has been in operation.

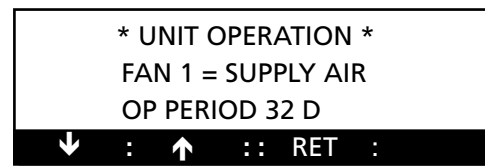

6.6.13 Fan sizes

SA FAN indicates the size of supply air fan connected to the unit. EA FAN indicates the size of exhaust air fan connected to the unit.

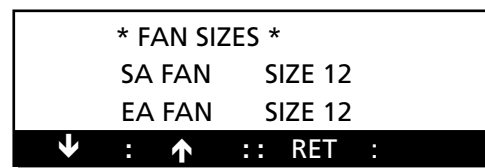

6.7 Control Settings Menu Group

This menu can be reached from the start menu for functions, entering alarm settings, entering cooler settings, running manual tests, viewing readings and entering control settings by pressing the **INST** button when the menu image indicates **CONTROL SETTINGS**, as described in Section 6.1.

6.7.1 Min./max. Settings

This is used to enable limiting the setting options for the temperature set points in the hand terminal. SET POINT indicates the lowest and the highest permissible temperature setting (in this case 15 °C and 25°C respectively); the exhaust air temperature for exhaust air regulation and the supply air temperature for supply air regulation.

MIN SA indicates the lowest and the highest permissible setting for min. supply air temperature for exhaust air regulation.
 MAX EA indicates the lowest and the highest permissible setting for max. supply air temperature for exhaust air regulation.

BREAKPOINT indicates the lowest and the highest permissible breakpoint setting for ERS regulation.
 EA/SA DIFF indicates the lowest and the highest permissible differential between the exhaust air and supply air for ERS regulation.

To alter the preset value

Press the **PROG** button and then press the **←** or **→** buttons to advance to the function that is to be altered. Then press on the **+** or **-** button to alter the value.

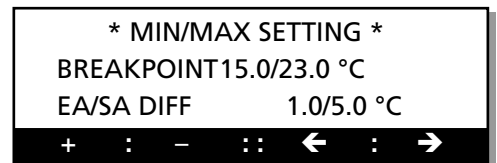
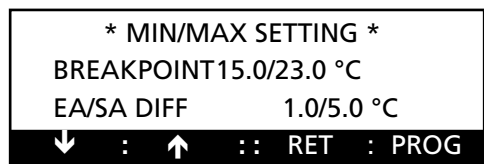
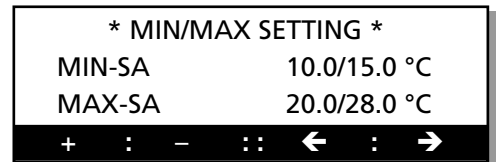
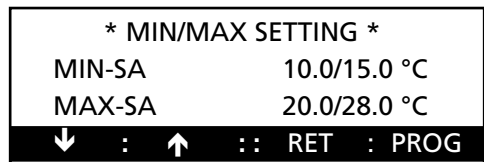
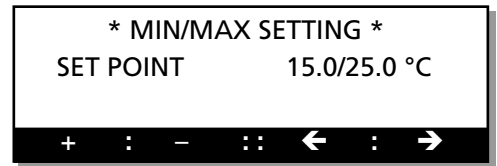
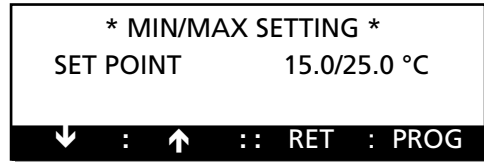

6.7.2 Feedback-control Speed

Used for increasing or decreasing the speed if special needs have to be met.
 TEMP SA shows the preset feedback-control speed of the supply air controller.
 TEMP EA shows the preset feedback-control speed of the exhaust air controller.
 TEMP SA and TEMP EA can be set from 0 to 9, where 0 provides speedier control and 9 provides slower control.

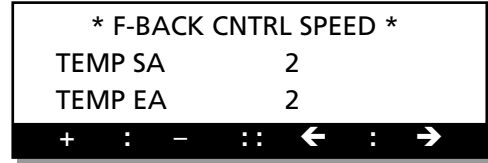
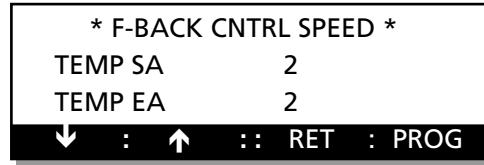

VAV SA shows the preset feedback-control speed of the supply air controls.
 VAV EA shows the preset feedback-control speed of the exhaust air controls.
 VAV SA and VAV EA can be set from 0 to 9, where 0 provides speedier control and 9 provides slower control.

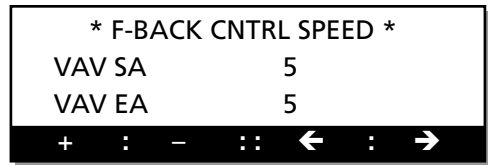
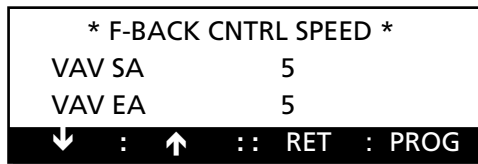

To alter the preset value

Press the **PROG** button and then press the **←** or **→** buttons to advance to the value that is to be altered. Then press on the **+** or **-** button to alter the value.

6.7.3 Outdoor Temperature Compensation

Used for adjusting the starting and end points for winter and summer compensation. See also Section 6.2.6
 X1 indicates where the preset winter compensation curve ends; -20 °C in this case.
 X2 indicates where the preset winter compensation curve begins; 10 °C in this case.
 X3 indicates where the summer compensation curve begins; 25 °C in this case.
 X4 indicates where the summer compensation curve ends; 40 °C in this case.

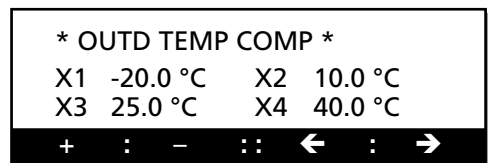
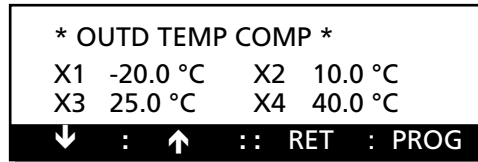

To alter the preset value

Press the **PROG** button and then press the **←** or **→** buttons to advance to the value that is to be altered. Then press on the **+** or **-** button to alter the value.

6.7.4 Outdoor Temperature Compensation, Flow/VAV

Used for adjusting the starting and end points for winter compensation. See also Section 6.2.6. X1 indicates where the preset winter compensation curve ends; -20 °C in this case. X2 indicates where the preset winter compensation curve begins; 10 °C in this case.

To alter the preset value

Press the **PROG** button and then press the **←** or **→** button to advance to value that is to be altered. Then press the **+** or **-** button to alter the value.

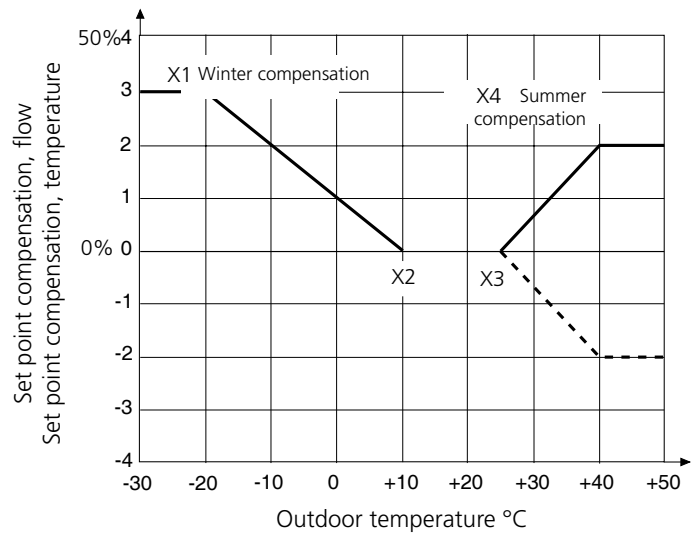
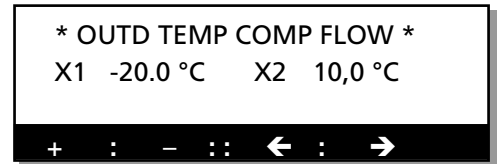
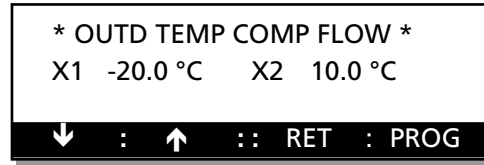

Fig 4

6.7.5 Switching Frequency

Used for adjusting the switching frequency of the frequency converter. A lower frequency setting will give the motor and frequency converter a longer the useful life, however the motor will generate more noise.

Caution! Increasing the switching frequency may affect the useful life of the frequency converter and the motor. SUPPLY AIR indicates the preset switching frequency for the frequency converter of the supply air fan. EXHAUST AIR indicates the preset switching frequency for the frequency converter of the exhaust air fan.

To alter the preset value

Press the **PROG** button and then press the **←** or **→** button to advance to value that is to be altered. Then press the **+** or **-** button to alter the value.

6.7.6 Regulating the SA flow to the min. set point in the VAV regulation mode, Neutral Zone for Regulating the SA Flow to the min. Set Point, Starting up Time

Regulating the supply airflow to the min. set point in the VAV control mode

Whenever VAV regulation is selected, scope is provided for regulating the supply airflow to the min. set point as a sequence in the temperature regulation mode. VAV SA REG TO MIN SETP indicates whether the function is activated (=1) or not (=0).

Neutral zone for regulating the SA flow to the min. set point

Whenever ERS or supply air regulation is selected, scope is provided for determining when SA flow regulation to the min. set point shall start. A settable temperature decrease permits a lower supply air set point before regulation to the min. set point will switch in. NZ SA REG TO MIN SETP indicates the preset neutral zone before regulating to a min. set point is begins.

Sequential starting up

To prevent cold air from being drawn unchecked through the GOLD unit during the starting up phase, the exhaust air fan is started first while the supply air fan starting is delayed. This delay is adjustable: 0--10 min. This forces the rotary heat exchanger to operate at max. rpm for 5 minutes. If the system includes an air heater for hot water, the hot water circuit valve is opened to 50%. START UP TIME shows the preset delay for switching in the supply air fan.

To alter the preset value

Press the **PROG** button and then press the **←** or **→** button to advance to value that is to be altered. Then press the **+** or **-** button to alter the value.

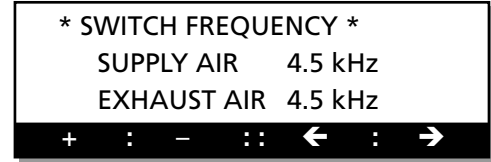
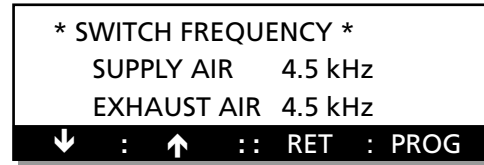

6.7.7 Factory Setting

FACTORY SETTING = 1 restores all the settings to the basic settings. The preset language is not affected. Setting 1 = On (the function has been selected). The changeover will occur when you return to the Main Menu.

To alter the settings

Press the **PROG** button. The image will then switch to a submenu, in which the setting selected can be altered.

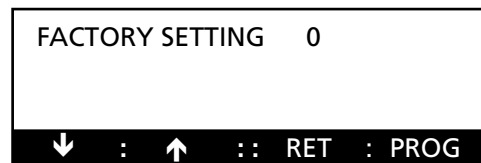

7. DESCRIPTION OF THE OTHER FUNCTIONS

7.1 Cooling Energy Recovery Function

Cooling energy recovery is an automatic function, which enables the unit to utilize the relative "cooling energy" that may be available indoors, when the outdoor temperature is high and cooling is required. The heat exchanger rotates at maximum speed and in this way recovers the relative cooling energy in the exhaust air. Before this function can be activated, cooling energy must be required and the outdoor temperature must be 1°C higher than the exhaust air. This function will be switched out when cooling is no longer needed or when the outdoor temperature is the same as that of the exhaust air.

The COOL RECOVERY caption and ordinary text will alternately flash in the main menu.

7.2 Intermittent Purging Function

The purpose of this function is to rotate the heat recovery rotor from time to time so that it won't remain in the same position in the air stream for a long period when heating isn't needed.

This function starts up whenever the air handling unit has been operating for 8 hours and the heat recovery rotor hasn't rotated. The rotary heat exchanger then operates for 3 minutes at a time to permit the air to pass through the rotor in both directions to remove possible dust from the rotor passages.

7.3 Heat Exchanger Rotation Monitor

The heat exchanger is continuously tested to confirm its rotation by means of a physical detector.

If the detector doesn't obtain a pulse signal within 30 seconds, the controller will attempt to restart the unit before an alarm is initiated.

7.4 Zero Calibration

The zero setting of the pressure transmitter is checked for 3 minutes after the unit has been shut down. The ZERO SET CALIBR caption flashes in the main menu while the control unit conducts a new calibration. The fans cannot be started up while calibration is in progress.

7.5 Low Speed/High Speed Switching

There are three ways to switch between preset low airflow and high airflow operation:

- 1 Manual switching in the main menu. See Section 5.1.
- 2 Programmed switching using the switching clock integrated in the control unit. See Section 5.4.
- 3 Remote switching across the external contact function input on terminals 31 and 32.

Manual switching between low speed and high speed operation has precedence over the switching clock (time switch) and input signals for switching from an external source. A manually entered low speed setting switches the unit to low speed operation.

High-speed operation activated from an external source has precedence over the stop or low-speed setting switched in by the switching clock. For particulars of prolonged operation, see Section 7.9.

7.6 Summer Night Cooling

To activate the function, see Section 6.2.5.

The summer night cooling function uses the lower outdoor air temperature at night to cool the building structure. This provides a lower initial cooling load during the day. If the summer night cooling function is activated, the fans in the unit operate at high speed to supply 10°C air (set point) from the preset start time until the prerequisites for switching out the function have been met.

The outdoor air temperature, start/stop (switch-in/switch-out), exhaust air temperature and start-up time settings can be altered in the summer night cooling sub-menu. The start-up time is factory preset at 23:00 hours.

Conditions that must be satisfied before the summer night cooling function will start at the preset time:

- The exhaust air temperature must be above the preset value (+22°C).
- The exhaust air temperature is at least 2°C warmer than the outdoor air.
- The outdoor air temperature must be above the preset value (+10°C).
- No heating has been required between 12.00-23.00 hours.
- The unit must not operate at high speed or be shut down from a remote terminal or manually from the hand-held terminal.

Conditions that must be satisfied before the summer night cooling function will stop:

- The exhaust air temperature drops below the preset value (+16°C).
- The outdoor temperature drops below the preset value (+10°C).
- The switching clock or external input calls for high-speed operation.
- The buttons on the hand-held terminal are enabled.

7.7 Set Point Displacement

To activate the function, see Section 6.2.8

Set point displacement is used for altering the supply air and exhaust air temperature set points by means of an external 0 - 10 V DC signal. The set point can be offset by +/-5°C.

If supply air regulation has been selected, the function will offset the supply air temperature and if exhaust air regulation has been selected, the function will offset the exhaust air temperature.

When the function is activated, the set point will be displaced as illustrated in the adjacent chart. 0 V DC decreases the temperature set point by 5°C, a 5 V DC signal doesn't change the set point and a 10 V DC signal raises the set point by 5°C. See the chart in Fig 5.

If ERS regulation has been selected, the SA/EA differential will be influenced. This differential cannot be lower than 0°C. The SA/EA differential decreases if the input signal is increased.

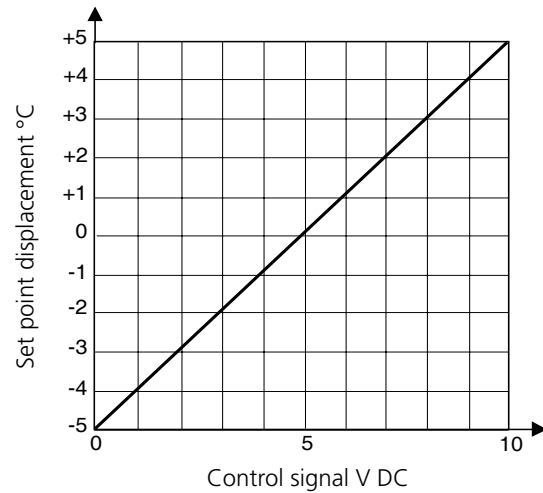

Fig 5

7.8 High-speed Fan Operation Indication

The HIGH SPEED relay output will be energized whenever the air handling unit is operated in the high speed, summer night cooling, VAV regulation or the boosted air flow mode.

7.9 External Input for High-Speed Operation

If the air handling unit is operating at low speed or if it has been switched out by the switching clock, closure of the EXT HS INPUT will cause the unit to operate at HIGH SPEED.

7.10 External Input for Low-speed Operation

If the switching clock has switched out the unit (stop - low speed operation), closure of the EXT LS INPUT will cause the unit to operate at LOW SPEED.

7.11 Anti-frosting Monitor Function

The anti-frosting monitor function is always active if the ventilation system includes an air heater for hot water.

When the function is active, the water temperature in the air heater will be kept at 13°C while the air handling unit is operating and at 25°C while the unit is shut down. The function contains a monitor that will switch out the unit and initiate an alarm if the temperature sensor senses a water temperature below 7°C.

7.12 Three Types of Airflow Regulation

Constant flow

To activate the function, see Section 6.2.2.

Constant flow (referred to only as FLOW in the menu) implies that the GOLD unit maintains a constant preset airflow rate. The control equipment automatically controls the speed of the fans to enable correct air flow as the filters begin to be contaminated, air devices become blocked, etc.

Constant air flow maintained by the air handling unit is of great benefit to the user because the air flow is always as it was preset when the unit was commissioned.

It is however important to keep in mind that everything that increases the pressure drop in the ventilation system, such as possible blanking off of air devices, will also automatically cause the fans to operate at a higher rpm. This will in turn cause the fans to consume more power and may also give rise to comfort ventilation problems such as draughts and excessive noise.

VAV Regulation

To activate the function, see Section 6.2.2.

VAV stands for Variable Air Volume and is available in two different variants.

VAV pressure

The control equipment keeps the pressure in the ducting constant in response to a 0-10 V input signal from an external pressure sensor, arranged inside the duct. The set point setting required (separate for low and high speed) can be entered as a percentage of the range of the pressure sensor (Section 5.6.6).

The function can be restricted, so that the airflow rate will not exceed the preset max. flow rates (Section 5.6.5).

VAV demand

The control equipment keeps the flow rate required constant in response to a 0-10 V input signal from an external sensor, such as a carbon dioxide sensor. The set point setting required (separate for low and high speed) can be entered as a percentage of the input signal (Section 5.6.6). The function can be restricted, so that the airflow will not exceed or be less than the preset max. and min. flow rates respectively (Section 5.6.4).

Boosted Air Flow (Forcing)

To activate the function, see Section 6.2.2.

The control equipment controls the speed of the fans between two flow rates on receiving input signals from an external sensor (e.g. a sensor or a potentiometer).

The basic air flow can be preset in the High-speed menu (Section 5.6.3). Max. air flow can be preset in the Max-speed menu (Section 5.6.4). During periods when the fans are set to run at low speed, such as at night, the forcing (boosted air flow) function will not have any effect.

7.13 Communication

The GOLD can be connected to a master system, either across external inputs and outputs or with a GOLD LON adapter across a LonWorks network. It is also possible to communicate via the GSM network by utilising the Swegon GOLDen EYE monitoring system.

7.14 Recooling the Reheater

If the reheater is switched out, the fans will operate for 3 minutes at min. airflow speed to cool off the air heater, even if a stop order is keyed on the hand-held terminal. The text "RECOOLING" will flash on the second line in the display.

7.15 Supply Air Flow Regulation to Min. Set Point

Supply airflow control to the minimum set point is linked as the final stage in the heat control sequence. Whenever heating is required, the heat exchanger will first start up. The air reheater, if fitted, will be switched in and its output will be modulated to max. If the air temperature sensed by the supply air sensor is still too low, the control system will decelerate the supply air fan. This will regulate the flow of supply air down to the minimum set point.

Only the supply air flow can be regulated in this manner. The purpose of this function is to alter the relationship between the supply air and the exhaust air flows in order to enhance the efficiency of the heat exchanger. The correct supply air temperature is given precedence over the programmed air flow.

This function regulates the supply air flow from the current programmed flow rate (high speed or low speed operation), down to half of this flow rate. The function is also limited by the min. flow setting of the unit. If the low speed air flow setting is close to the min. flow rate, regulation to the min. set point will have little effect.

It is also possible to control the starting time for when the supply airflow is to be regulated to the min. set point. An adjustable temperature reduction setting permits a lower supply air set point before the controller switches in the regulation to the min. set point function. The neutral zone can be preset on the NZ SA REG TO MIN SETP line in the menu (see Section 6.7.6).

Prerequisites for enabling this function:

When Fan Regulation is set at FLOW, the supply airflow will be automatically regulated to the min. set point.

When VAV-regulation is activated, it is possible to select SA flow regulation to the min. set point on the NZ SA REG TO MIN SETP line in the menu (see Section 6.7.6). The supply air flow cannot be regulated to the min. set point if FORCING is activated.

Temperature regulation must be set at SA or ERS regulation. The supply air flow cannot be regulated to the min. set point if Exhaust Air Regulation has been selected.

8. ALARMS

Alarms are displayed in plain text in the terminal display. A red flashing lamp in button no. 4 on the hand-held terminal also indicates an alarm.

A typical alarm text in the display menu:

```

***      ALARM 47      ***
          SUPPLY AIR FILTER
          DIRTY
    
```

Explanation of the alarms

All the alarm texts for Alarms 1 through 49 are described and the following information is given about them on the next pages:

Resetting:

Manual reset involves, if not otherwise specified, pressing the RES button on the hand-held terminal. Automatic reset means that the alarm will be reset as soon as the fault has been remedied.

Time delay:

Time delay means that the alarm will not trip directly as the fault is registered; it will trip either if the fault has existed for a specific period or if the fault has repeatedly occurred a specific number of times.

Remedial action:

The cause of the alarm is specified, and if possible also a few simple spots to check for fault tracing.

CAUTION! *If despite your efforts you haven't been able to correct the fault, get in touch with Swegon Service.*

Other notes:

The alarms are not activated in the programming menus. The fire alarm and the anti-frosting monitor alarm are the only ones that are active in all the menu images. The other alarms are only active in the main images.

For selecting of alarm priority, how to block alarms and function, see 6.3.6.

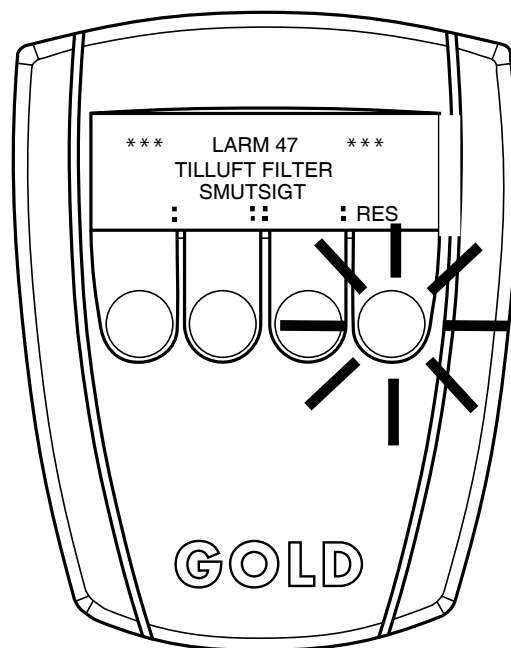

Hand-held terminal with flashing alarm lamp

Alarm 1

EXTERNAL FIRE ALARM TRIPPED

Displayed if signal transmission to the fire alarm input in the control unit is interrupted. The alarm relay (priority) required and the alarm indication (LED) can be preset in the hand-held terminal.

Always stops the air handling unit and cannot be deselected. The alarm priority cannot be set at 0; therefore the alarm cannot be blocked.

Factory setting: Priority A, Indication 1, Stop 1.

Time delay before the alarm trips: 3 seconds.

Manual reset.

Alarm 2

INTERNAL FIRE ALARM TRIPPED

Displayed if the supply air temperature sensor measures more than 70°C and/or if the exhaust air temperature sensor measures more than 50°C. The alarm relay (priority) required and the alarm indication (LED) can be preset in the hand-held terminal.

Always stops the air handling unit and cannot be deselected. The alarm priority cannot be set at 0; therefore the alarm cannot be blocked.

Factory setting: Priority A, Indication 1, Stop 1.

Time delay before the alarm trips: 3 seconds.

Manual reset.

Alarm 3

ANTI-FROST TEMP BELOW ALARM LIMIT

Displayed if the anti-frosting monitor has sensed a temperature below 7°C. The alarm is obtained in all the menus. The alarm relay (priority) required and the alarm indication (LED) can be preset in the hand-held terminal.

Always stops the air handling unit and cannot be deselected. The alarm priority cannot be set at 0; therefore the alarm cannot be blocked.

Factory setting: Priority A, Indication 1, Stop 1.

Time delay before the alarm trips: 3 seconds.

Manual reset.

Alarm 4

H EXCH ROTATION MONITOR TRIPPED

Displayed if the rotation monitor sensor of the heat exchanger controller has not received any signal. The alarm is displayed only if the hand-held terminal is in the main menu.

The alarm relay (priority) required and the alarm indication (LED) can be preset in the hand-held terminal.

Always stops the air handling unit if the outdoor temperature is below 5°C or if heating is required. The alarm priority cannot be set at 0; the alarm therefore cannot be blocked.

Factory setting: Priority A, Indication 1. Time delay before the alarm trips: 30 seconds.

Manual reset.

Alarm 5

ANTI-FROST SENSOR FAULTY

Displayed if the anti-frosting temperature sensor is not connected or is faulty. If the alarm is initiated while the AHU is energised, only the temperature reading will be displayed in the hand-held terminal. If the AHU isn't energised, 0°C will be displayed in the hand-held terminal when the AHU ultimately is energised.

The alarm priority cannot be set at 0; therefore the alarm cannot be blocked.

Factory setting: Priority A. Indication 1. Stop 1.

Time delay before the alarm trips: 5 seconds.

Automatic reset.

Alarm 6

SUPPLY AIR SENSOR FAULTY

Displayed if the supply air sensor is not connected or is faulty. If the alarm is initiated while the AHU is energised, only the temperature reading will be displayed in the hand-held terminal. If the AHU isn't energised, 0°C will be displayed in the hand-held terminal when the AHU ultimately is energised.

The alarm is displayed only if the hand-held terminal is in the main menu.

The alarm relay (priority) required, the alarm indication (LED) and whether the alarm shall force the air handling unit to stop can be preset in the hand-held terminal.

The alarm priority can be set at 0; this will block the alarm.

Factory setting: Priority A, Indication 1, Stop 1.

Time delay before the alarm trips: 5 seconds.

Automatic reset.

Alarm 7

EXHAUST AIR SENSOR FAULTY

Displayed if the exhaust air sensor is not connected or is faulty. If the alarm is initiated while the AHU is energised, only the temperature reading will be displayed in the hand-held terminal. If the AHU isn't energised, 0°C will be displayed in the hand-held terminal when the AHU ultimately is energised.

The alarm is displayed only if the hand-held terminal is in the main menu.

The alarm relay (priority) required, the alarm indication (LED) and whether the alarm shall force the air handling unit to stop can be preset in the hand-held terminal.

The alarm priority can be set at 0; this will block the alarm.

Factory setting: Priority A, Indication 1, Stop 1.

Time delay before the alarm trips: 5 seconds.

Automatic reset.

Alarm 8**OUTDOOR AIR SENSOR FAULTY**

Displayed if the outdoor air sensor is not connected or is faulty. If the alarm is initiated while the AHU is energised, only the temperature reading will be displayed in the hand-held terminal. If the AHU isn't energised, 0°C will be displayed in the hand-held terminal when the AHU ultimately is energised.

The alarm is displayed only if the hand-held terminal is in the main menu.

The alarm relay (priority) required, the alarm indication (LED) and whether the alarm shall force the air handling unit to stop can be preset in the hand-held terminal.

The alarm priority can be set at 0; this will block the alarm.

Factory setting: Priority B, Indication 1, Stop 0.

Time delay before the alarm trips: 5 seconds.

Automatic reset.

Alarm 9**NO COMMUNICATION W HEAT EXCH CONTROLLER**

Displayed if the control unit doesn't obtain correct communication from the heat exchanger controller. The default value 0% is indicated in the hand-held terminal if the heat exchanger control is faulty or is not connected.

The alarm is displayed only if the hand-held terminal is in the main menu.

The alarm relay (priority) required, the alarm indication (LED) and whether the alarm shall force the air handling unit to stop can be preset in the hand-held terminal.

The alarm priority can be set at 0; this will block the alarm.

Factory setting: Priority A, Indication 1, Stop 1.

Time delay before the alarm trips: 10 seconds.

Automatic reset.

Alarm 10**NO COMMUNICATION SA FREQUENCY CONV.**

Displayed if the control unit doesn't obtain correct communication from the frequency converter of the supply air fan motor. The default value 0% is indicated in the hand-held terminal if the frequency converter is faulty or is not connected.

The alarm is displayed only if the hand-held terminal is in the main menu.

The alarm relay (priority) required, the alarm indication (LED) and whether the alarm shall force the air handling unit to stop can be preset in the hand-held terminal.

The alarm priority can be set at 0; this will block the alarm.

Factory setting: Priority A, Indication 1, Stop 1.

Time delay before the alarm trips: 10 seconds.

Automatic reset.

Alarm 11**NO COMMUNICATION EA FREQUENCY CONV.**

Displayed if the control unit doesn't obtain correct communication from the frequency converter of the exhaust air fan motor. The default value 0 Pa, %, Hz is indicated in the hand-held terminal if the frequency converter is faulty or is not connected.

The alarm is displayed only if the hand-held terminal is in the main menu.

The alarm relay (priority) required, the alarm indication (LED) and whether the alarm shall force the air handling unit to stop can be preset in the hand-held terminal.

The alarm priority can be set at 0; this will block the alarm.

Factory setting: Priority A, Indication 1, Stop 1.

Time delay before the alarm trips: 10 seconds.

Automatic reset.

Alarm 12**OVERCURRENT SA FREQUENCY CONV.**

Displayed if the frequency converter of the supply air fan motor trips due to excessively high current.

The alarm is displayed only if the hand-held terminal is in the main menu.

The alarm relay (priority) required, the alarm indication (LED) and whether the alarm shall force the air handling unit to stop can be preset in the hand-held terminal.

The alarm priority can be set at 0; this will block the alarm.

Factory setting: Priority A, Indication 1, Stop 1.

Time delay before the alarm trips: 10 seconds.

Manual reset.

Alarm 13**OVERCURRENT EA FREQUENCY CONV.**

Displayed if the frequency converter of the exhaust air fan motor trips due to excessively high current.

The alarm is displayed only if the hand-held terminal is in the main menu.

The alarm relay (priority) required, the alarm indication (LED) and whether the alarm shall force the air handling unit to stop can be preset in the hand-held terminal.

The alarm priority can be set at 0; this will block the alarm.

Factory setting: Priority A, Indication 1, Stop 1.

Time delay before the alarm trips: 10 seconds.

Manual reset.

Alarm 14**UNDERVOLTAGE SA FREQUENCY CONV.**

Displayed if the wrong voltage is supplied to the frequency converter of the supply air fan motor. Check that the power supply fuses are intact and that power is supplied to all phases. Also check that the motor protection switch is ON (applies to the size 21-52 units). Measure all phases to make sure that undercurrent or overcurrent is not supplied.

The alarm is displayed only if the hand held terminal is in the main menu.

The alarm relay (priority) required, the alarm indication (LED) and whether the alarm shall force the air handling unit to stop can be preset in the hand-held terminal.

The alarm priority can be set at 0; this will block the alarm.

Factory setting: Priority A, Indication 1, Stop 1.

Time delay before the alarm trips: 10 seconds.

Manual reset.

Alarm 15**UNDERVOLTAGE EA FREQUENCY CONV.**

Displayed if the wrong voltage is supplied to the frequency converter of the exhaust air fan motor. Check that the power supply fuses are intact and that power is supplied to all phases. Also check that the motor protection switch is ON (applies to the size 21-52 units). Measure all phases to make sure that undercurrent or overcurrent is not supplied.

The alarm is displayed only if the hand held terminal is in the main menu.

The alarm relay (priority) required, the alarm indication (LED) and whether the alarm shall force the air handling unit to stop can be preset in the hand-held terminal.

The alarm priority can be set at 0; this will block the alarm.

Factory setting: Priority A, Indication 1, Stop 1.

Time delay before the alarm trips: 10 seconds.

Manual reset.

Alarm 16**LOW VOLTAGE ERROR IN SA FREQUENCY CONV.**

Displayed if the wrong voltage is supplied across the bus (24 V DC) to the frequency converter of the supply air fan motor.

Check all pins of the bus cable between the control printed-circuit card and the frequency converter. Also check that the voltage from the transformer is correct (18 V AC between terminals 59 and 60 on control card).

The alarm is displayed only if the hand held terminal is in the main menu.

The alarm relay (priority) required, the alarm indication (LED) and whether the alarm shall force the air handling unit to stop can be preset in the hand-held terminal.

The alarm priority can be set at 0; this will block the alarm.

Factory setting: Priority A, Indication 1, Stop 1.

Time delay before the alarm trips: 10 seconds.

Manual reset.

Alarm 17**LOW VOLTAGE ERROR IN EA FREQUENCY CONV.**

Displayed if the wrong voltage is supplied across the bus (24 V DC) to the frequency converter of the exhaust air fan motor.

Check all pins of the bus cable between the control printed-circuit card and the frequency converter. Also check that the voltage from the transformer is correct (18 V AC between terminals 59 and 60 on control card).

The alarm is displayed only if the hand held terminal is in the main menu.

The alarm relay (priority) required, the alarm indication (LED) and whether the alarm shall force the air handling unit to stop can be preset in the hand-held terminal.

The alarm priority can be set at 0; this will block the alarm.

Factory setting: Priority A, Indication 1, Stop 1.

Time delay before the alarm trips: 10 seconds.

Manual reset.

Alarm 18**OVERTEMP SA FREQUENCY CONV.**

Displayed if the frequency converter of the supply air fan motor trips due to excessively high temperature.

The alarm is displayed only if the hand held terminal is in the main menu.

The alarm relay (priority) required, the alarm indication (LED) and whether the alarm shall force the air handling unit to stop can be preset in the hand-held terminal.

The alarm priority can be set at 0; this will block the alarm.

Factory setting: Priority A, Indication 1, Stop 1.

Time delay before the alarm trips: 10 seconds.

Manual reset.

Alarm 19**OVERTEMP EA FREQUENCY CONV.**

Displayed if the frequency converter of the exhaust air fan motor trips due to excessively high temperature.

The alarm is displayed only if the hand held terminal is in the main menu.

The alarm relay (priority) required, the alarm indication (LED) and whether the alarm shall force the air handling unit to stop can be preset in the hand-held terminal.

The alarm priority can be set at 0; this will block the alarm.

Factory setting: Priority A, Indication 1, Stop 1.

Time delay before the alarm trips: 10 seconds.

Manual reset.

Alarm 20

Applies to the size 41 and 52 units

NO COMMUNICATION SA FREQUENCY CONV.

Displayed if the slave frequency inverter in the supply airflow doesn't receive correct communication from the supply air motor frequency inverter. The default value 0% is indicated in the hand-held terminal if the frequency converter is faulty or is not connected.

The alarm is displayed only if the hand-held terminal is in the main menu.

The alarm relay (priority) required, the alarm indication (LED) and whether the alarm shall force the air handling unit to stop can be preset in the hand-held terminal.

The alarm priority can be set at 0; this will block the alarm.

Factory setting: Priority A, Indication 1, Stop 1.

Time delay before the alarm trips: 10 seconds.

Automatic reset.

Alarm 21

Applies to the size 41 and 52 units

NO COMMUNICATION EA FREQUENCY CONV.

Displayed if the slave frequency inverter in the extract airflow doesn't receive correct communication from the extract air motor frequency inverter. The default value 0 Pa, %, Hz is indicated in the hand-held terminal if the frequency converter is faulty or is not connected.

The alarm is displayed only if the hand-held terminal is in the main menu.

The alarm relay (priority) required, the alarm indication (LED) and whether the alarm shall force the air handling unit to stop can be preset in the hand-held terminal.

The alarm priority can be set at 0; this will block the alarm.

Factory setting: Priority A, Indication 1, Stop 1.

Time delay before the alarm trips: 10 seconds.

Automatic reset.

Alarm 22

Applies to the size 41 and 52 units

OVERCURRENT SA FREQUENCY CONV.

Displayed if the slave frequency inverter in the supply airflow trips due to excessively high current.

The alarm is displayed only if the hand-held terminal is in the main menu.

The alarm relay (priority) required, the alarm indication (LED) and whether the alarm shall force the air handling unit to stop can be preset in the hand-held terminal.

The alarm priority can be set at 0; this will block the alarm.

Factory setting: Priority A, Indication 1, Stop 1.

Time delay before the alarm trips: 10 seconds.

Manual reset.

Alarm 23

Applies to the size 41 and 52 units

OVERCURRENT EA FREQUENCY CONV.

Displayed if the slave frequency inverter in the extract airflow trips due to excessively high current.

The alarm is displayed only if the hand-held terminal is in the main menu.

The alarm relay (priority) required, the alarm indication (LED) and whether the alarm shall force the air handling unit to stop can be preset in the hand-held terminal.

The alarm priority can be set at 0; this will block the alarm.

Factory setting: Priority A, Indication 1, Stop 1.

Time delay before the alarm trips: 10 seconds.

Manual reset.

Alarm 24

Applies to the size 41 and 52 units

UNDERVOLTAGE SA FREQUENCY CONV.

Displayed if the wrong current is supplied to the slave frequency inverter in the supply airflow. Check that the power supply fuses are intact and that power is supplied to all phases. Also check that the motor protection switch is ON (applies to the size 21-52 units). Measure all phases to make sure that undercurrent or overcurrent is not supplied.

The alarm is displayed only if the hand held terminal is in the main menu.

The alarm relay (priority) required, the alarm indication (LED) and whether the alarm shall force the air handling unit to stop can be preset in the hand-held terminal.

The alarm priority can be set at 0; this will block the alarm.

Factory setting: Priority A, Indication 1, Stop 1.

Time delay before the alarm trips: 10 seconds.

Manual reset.

Alarm 25

Applies to the size 41 and 52 units

UNDERVOLTAGE EA FREQUENCY CONV.

Displayed if the wrong current is supplied to the slave frequency inverter in the extract airflow. Check that the power supply fuses are intact and that power is supplied to all phases. Also check that the motor protection switch is ON (applies to the size 21-52 units). Measure all phases to make sure that undercurrent or overcurrent is not supplied.

The alarm is displayed only if the hand held terminal is in the main menu.

The alarm relay (priority) required, the alarm indication (LED) and whether the alarm shall force the air handling unit to stop can be preset in the hand-held terminal.

The alarm priority can be set at 0; this will block the alarm.

Factory setting: Priority A, Indication 1, Stop 1.

Time delay before the alarm trips: 10 seconds.

Manual reset.

Alarm 26

Applies to the size 41 and 52 units

LOW VOLTAGE ERROR IN SA FREQUENCY CONV.

Displayed if the wrong/low current is supplied via bus (24VDC) to the slave frequency inverter in the supply airflow.

Check all pins of the bus cable between the control printed-circuit card and the frequency converter. Also check that the voltage from the transformer is correct (18 V AC between terminals 59 and 60 on control card).

The alarm is displayed only if the hand held terminal is in the main menu.

The alarm relay (priority) required, the alarm indication (LED) and whether the alarm shall force the air handling unit to stop can be preset in the hand-held terminal.

The alarm priority can be set at 0; this will block the alarm.

Factory setting: Priority A, Indication 1, Stop 1.

Time delay before the alarm trips: 10 seconds.

Manual reset.

Alarm 27

Applies to the size 41 and 52 units

LOW VOLTAGE ERROR IN EA FREQUENCY CONV.

Displayed if the wrong/low current is supplied via bus (24VDC) to the slave frequency inverter in the extract airflow.

Check all pins of the bus cable between the control printed-circuit card and the frequency converter. Also check that the voltage from the transformer is correct (18 V AC between terminals 59 and 60 on control card).

The alarm is displayed only if the hand held terminal is in the main menu.

The alarm relay (priority) required, the alarm indication (LED) and whether the alarm shall force the air handling unit to stop can be preset in the hand-held terminal.

The alarm priority can be set at 0; this will block the alarm.

Factory setting: Priority A, Indication 1, Stop 1.

Time delay before the alarm trips: 10 seconds.

Manual reset.

Alarm 28

Applies to the size 41 and 52 units

OVERTEMP SA FREQUENCY CONV.

Displayed if the slave frequency inverter in the supply airflow trips due to excessively high temperature.

The alarm is displayed only if the hand held terminal is in the main menu.

The alarm relay (priority) required, the alarm indication (LED) and whether the alarm shall force the air handling unit to stop can be preset in the hand-held terminal.

The alarm priority can be set at 0; this will block the alarm.

Factory setting: Priority A, Indication 1, Stop 1.

Time delay before the alarm trips: 10 seconds.

Manual reset.

Alarm 29

Applies to the size 41 and 52 units

OVERTEMP EA FREQUENCY CONV.

Displayed if the slave frequency inverter in the extract airflow trips due to excessively high temperature.

The alarm is displayed only if the hand held terminal is in the main menu.

The alarm relay (priority) required, the alarm indication (LED) and whether the alarm shall force the air handling unit to stop can be preset in the hand-held terminal.

The alarm priority can be set at 0; this will block the alarm.

Factory setting: Priority A, Indication 1, Stop 1.

Time delay before the alarm trips: 10 seconds.

Manual reset.

Alarms 30 - 32

Spare

Alarm 33**OVERTEMP H EXCH CONTROLLER**

Displayed if the temperature in the heat exchanger controller exceeds 90°C.

The alarm is displayed only if the hand held terminal is in the main menu.

The alarm relay (priority) required, the alarm indication (LED) and whether the alarm shall force the air handling unit to stop can be preset in the hand-held terminal.

The alarm priority can be set at 0; this will block the alarm.

Factory setting: Priority A, Indication 1, Stop 1.

Time delay before the alarm trips: 10 seconds.

Manual reset.

Alarm 34**EL AIR HEATER TRIPPED**

Displayed if the overheating protection of the electric air heater has tripped.

The alarm is displayed only if the hand held terminal is in the main menu.

The alarm relay (priority) required, the alarm indication (LED) and whether the alarm shall force the air handling unit to stop can be preset in the hand-held terminal.

The alarm priority can be set at 0; this will block the alarm.

Factory setting: Priority A, Indication 1, Stop 1.

Time delay before the alarm trips: 3 seconds.

Manual reset.

Alarm 35**EXHAUST AIR TEMP BELOW ALARM LIMIT**

Displayed if the exhaust air temperature reading in the hand-held terminal has been constantly below the alarm limit for 20 minutes. If the temperature rises above the alarm limit during the delay period, this will reset the time delay.

The alarm is displayed only if the hand held terminal is in the main menu.

The alarm relay (priority) required, the alarm indication (LED) and whether the alarm shall force the air handling unit to stop can be preset in the hand-held terminal.

The alarm priority can be set at 0; this will block the alarm.

Factory setting: Priority A, Indication 1, Stop 1.

Factory-preset alarm limit: 15°C

Time delay before the alarm trips: 20 minutes.

Manual reset.

Alarm 36**SUPPLY AIR TEMP BELOW SET POINT**

Displayed if the supply air temperature reading in the hand-held terminal has been constantly below the alarm limit for 20 minutes. If the temperature rises above the alarm limit during the delay period, this will reset the time delay.

The alarm is displayed only if the hand held terminal is in the main menu.

The alarm relay (priority) required, the alarm indication (LED) and whether the alarm shall force the air handling unit to stop can be preset in the hand-held terminal.

The alarm priority can be set at 0; this will block the alarm.

Factory setting: Priority A, Indication 1, Stop 1.

Factory-preset alarm limit: 5°C

Time delay before the alarm trips: 20 minutes.

Manual reset.

Alarm 37**EXTERNAL ALARM NO. 1 TRIPPED**

Displayed if the input contact on the control unit is closed/opened.

The alarm relay (priority) required, the alarm indication (LED) and whether the alarm shall force the air handling unit to stop can be preset in the hand-held terminal.

The alarm priority can be set at 0; this will block the alarm.

Factory setting: Priority A, Indication 1, Stop 0.

Manual reset.

Alarm 38**EXTERNAL ALARM NO. 2 TRIPPED**

Displayed if the input contact on the control unit is closed/opened.

The alarm relay (priority) required, the alarm indication (LED) and whether the alarm shall force the air handling unit to stop can be preset in the hand-held terminal.

The alarm priority can be set at 0; this will block the alarm.

Factory setting: Priority B, Indication 1, Stop 0.

Manual reset.

Alarm 39**SUPPLY AIR DUCT PRESSURE BELOW SET POINT**

Displayed if the supply air pressure has been more than 10 % below its set point for 20 minutes. If the pressure drops below the alarm limit during the delay period, this will reset the time delay.

The alarm is displayed only if the hand held terminal is in the main menu.

The alarm relay (priority) required, the alarm indication (LED) and whether the alarm shall force the air handling unit to stop can be preset in the hand-held terminal.

The alarm priority can be set at 0; this will block the alarm.

Factory setting: Priority B, Indication 1, Stop 0.

Time delay before the alarm trips: 20 minutes.

Manual reset.

Alarm 40**EXHAUST AIR DUCT PRESSURE BELOW SET POINT**

Displayed if the exhaust air pressure has been more than 10 % below its set point for 20 minutes. If the pressure drops below the alarm limit during the delay period, this will reset the time delay.

The alarm is displayed only if the hand held terminal is in the main menu.

The alarm relay (priority) required, the alarm indication (LED) and whether the alarm shall force the air handling unit to stop can be preset in the hand-held terminal.

The alarm priority can be set at 0; this will block the alarm.

Factory setting: Priority B, Indication 1, Stop 0.

Time delay before the alarm trips: 20 minutes.

Manual reset.

Alarm 41**SUPPLY AIR DUCT PRESSURE ABOVE SET POINT**

Displayed if the supply air pressure has been more than 10 % above its set point for 20 minutes. If the pressure drops below the alarm limit during the delay period, this will reset the time delay.

The alarm is displayed only if the hand held terminal is in the main menu.

The alarm relay (priority) required, the alarm indication (LED) and whether the alarm shall force the air handling unit to stop can be preset in the hand-held terminal.

The alarm priority can be set at 0; this will block the alarm.

Factory setting: Priority B, Indication 1, Stop 0.

Time delay before the alarm trips: 20 minutes.

Manual reset.

Alarm 42**EXHAUST AIR DUCT PRESSURE ABOVE SET POINT**

Displayed if the exhaust air pressure has been more than 10 % above its set point for 20 minutes. If the pressure drops below the alarm limit during the delay period, this will reset the time delay.

The alarm is displayed only if the hand held terminal is in the main menu.

The alarm relay (priority) required, the alarm indication (LED) and whether the alarm shall force the air handling unit to stop can be preset in the hand-held terminal.

The alarm priority can be set at 0; this will block the alarm.

Factory setting: Priority B, Indication 1, Stop 0.

Time delay before the alarm trips: 20 minutes.

Manual reset.

Alarm 43**SUPPLY AIR FLOW BELOW SET POINT**

Displayed if the supply air flow has been more than 10 % below the set point of the supply air controller for 20 minutes. If the flow drops below the alarm limit during the delay period, this will reset the time delay.

The alarm is displayed only if the hand held terminal is in the main menu.

The alarm relay (priority) required, the alarm indication (LED) and whether the alarm shall force the air handling unit to stop can be preset in the hand-held terminal.

The alarm priority can be set at 0; this will block the alarm.

Factory setting: Priority B, Indication 1, Stop 0.

Time delay before the alarm trips: 20 minutes.

Manual reset.

Alarm 44**EXHAUST AIR FLOW BELOW SET POINT**

Displayed if the exhaust air flow has been more than 10 % below the set point of the exhaust air controller for 20 minutes. If the flow drops below the alarm limit during the delay period, this will reset the time delay.

The alarm is displayed only if the hand held terminal is in the main menu.

The alarm relay (priority) required, the alarm indication (LED) and whether the alarm shall force the air handling unit to stop can be preset in the hand-held terminal.

The alarm priority can be set at 0; this will block the alarm.

Factory setting: Priority B, Indication 1, Stop 0.

Time delay before the alarm trips: 20 minutes.

Manual reset.

Alarm 45**SUPPLY AIR FLOW ABOVE SET POINT**

Displayed if the supply air flow has been more than 10 % above the set point of the supply air controller for 20 minutes. If the flow drops below the alarm limit during the delay period, this will reset the time delay.

The alarm is displayed only if the hand held terminal is in the main menu.

The alarm relay (priority) required, the alarm indication (LED) and whether the alarm shall force the air handling unit to stop can be preset in the hand-held terminal.

The alarm priority can be set at 0; this will block the alarm.

Factory setting: Priority B, Indication 1, Stop 0.

Time delay before the alarm trips: 20 minutes.

Manual reset.

Alarm 46**EXHAUST AIR FLOW ABOVE SET POINT**

Displayed if the exhaust air flow has been more than 10 % above the set point of the exhaust air controller for 20 minutes. If the flow drops below the alarm limit during the delay period, this will reset the time delay.

The alarm is displayed only if the hand held terminal is in the main menu.

The alarm relay (priority) required, the alarm indication (LED) and whether the alarm shall force the air handling unit to stop can be preset in the hand-held terminal.

The alarm priority can be set at 0; this will block the alarm.

Factory setting: Priority B, Indication 1, Stop 0.

Time delay before the alarm trips: 20 minutes.

Manual reset.

Alarm 47**SUPPLY AIR FILTER DIRTY**

Displayed if the pressure across the supply air filter constantly exceeds the alarm limit preset in the hand-held terminal for 10 minutes. If the pressure drops below the alarm limit during the delay period, this will reset the time delay.

The alarm is displayed only if the hand held terminal is in the main menu.

The alarm relay (priority) required, the alarm indication (LED) and whether the alarm shall force the air handling unit to stop can be preset in the hand-held terminal.

The alarm priority can be set at 0; this will block the alarm.

Factory setting: Priority B, Indication 1, Stop 0.

Time delay before the alarm trips: 10 minutes.

Manual reset.

Alarm 48**EXHAUST AIR FILTER DIRTY**

Displayed if the pressure across the exhaust air filter constantly exceeds the alarm limit preset in the hand-held terminal for 10 minutes. If the pressure drops below the alarm limit during the delay period, this will reset the time delay.

The alarm is displayed only if the hand held terminal is in the main menu.

The alarm relay (priority) required, the alarm indication (LED) and whether the alarm shall force the air handling unit to stop can be preset in the hand-held terminal.

The alarm priority can be set at 0; this will block the alarm.

Factory setting: Priority B, Indication 1, Stop 0.

Time delay before the alarm trips: 10 minutes.

Manual reset.

Alarm 49**SERVICE PERIOD EXCEEDS ALARM LIMIT**

Displayed if the period until the next scheduled service preset in the hand-held terminal has expired.

The alarm is displayed only if the hand held terminal is in the main menu.

The alarm relay (priority) required, the alarm indication (LED) and whether the alarm shall force the air handling unit to stop can be preset in the hand-held terminal.

The alarm priority can be set at 0; this will block the alarm.

If alarm is reset without the service period being entered in the hand-held terminal, the alarm will be displayed again in 7 days.

Factory setting: Priority B, Indication 1, Stop 0.

Factory-preset alarm limit: 12 months.

Manual reset.

9. MAINTENANCE

The safety precautions should be read in Section 2.

9.1 To change filters

9.1.1 General

If a filter alarm has been activated, the filters must be replaced.

The filters are disposable and must be replaced with new Class F7(F85) bag filters.

9.1.2 To remove contaminated filters

WARNING! At change of filters:

First stop the unit by pressing the STOP button on the hand-held terminal.

Then open the safety-isolating switch to isolate the power supply to the unit!

- Wait until the fans have stopped rotating before you open the inspection doors (to avoid overpressure).
- Open the inspection door of the filter/fan section.
- Pull the handles (A in Fig. 6) at the upper and lower edges of the filter mounting bracket outward, to open the off-centre guide.
- Remove the filters.

You are advised to clean all the surfaces inside the filter section when the filters have been removed. See Section 9.2.2.

In the size 11/12 and 15 units: Make sure that the vertical sealing strip that seals between the two filters is in place.

9.1.3 To insert new filters

- Fit the new filters.
Replacement filters (set):
For the size 11/12 GOLD units: TBFZ-1-01-10-7
For the size 15 GOLD units: TBFZ-1-01-15-7
For the size 21/22 GOLD units: TBFZ-1-01-20-7
For the size 31/32 GOLD units: TBFZ-1-01-30-7.
For the size 42 GOLD units: TBFZ-1-01-42-7
For the size 52 GOLD units: TBFZ-1-01-52-7.

CAUTION! As you insert the new filters, it's important to stretch the filter bags as shown by B in Fig. 7, so they won't catch, be damaged or be folded.

- Push each filter frame as far as you can into the section. Slightly press the filter frames to make them fit tightly against one another.
- Push in the handles (C in Fig. 8) at the upper and lower edges of the filter mounting bracket, to close the off-centre guide.
- Close the inspection door of the filter/fan section.
- Start the air handling unit by pressing the AUTO or MAN button on hand-held terminal.
- **AFTER CHANGING THE FILTERS, ALWAYS CARRY OUT A FILTER CALIBRATION. SEE SECTION 5.2.1.**

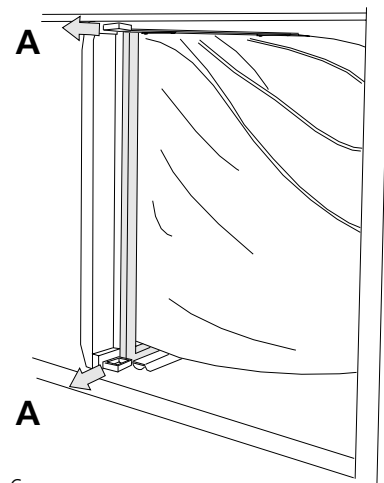

Fig 6

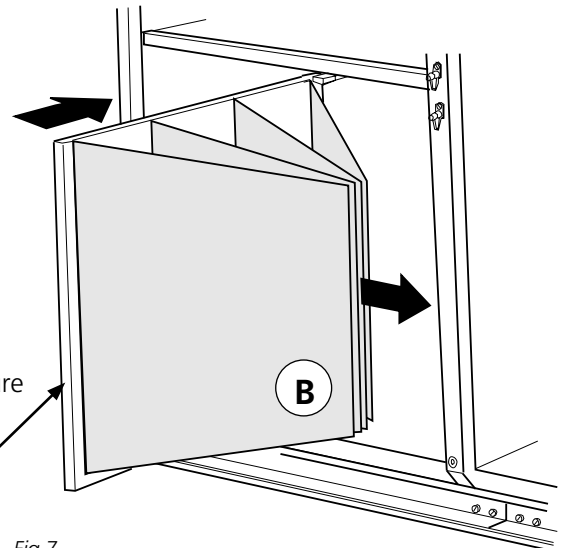

Fig 7

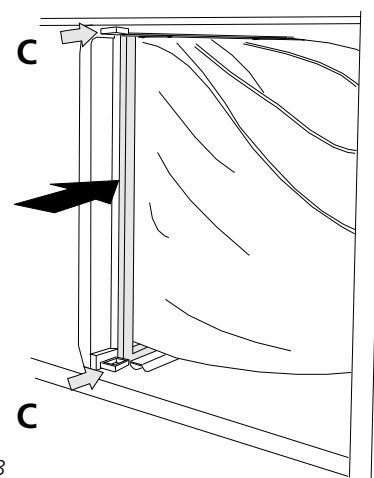

Fig 8

9.2 Cleaning

WARNING! Before cleaning:

First stop the unit by pressing the STOP button on the hand-held terminal.

Then open the safety-isolating switch to isolate the power supply to the unit!

9.2.1 General

Clean the inside of the unit whenever needed.

Check the unit every time you change the filters or at least once every six months.

9.2.2 To Clean the Surfaces inside the Filter Section

It is advisable to clean the surfaces inside the filter sections every time you change filters, after having removed the contaminated filters as described in Section 9.1.2.

- Stop the air handling unit and isolate the power supply by opening the safety-isolating switch.
- Wait until the fans have stopped rotating before you open the inspection door (to avoid overpressure).
- Open the inspection doors of the filter/fan sections. Remove the contaminated filters.
- Vacuum clean the surfaces inside the filter sections.

9.2.3 To clean the rotary heat exchanger

- Stop the air handling unit and isolate the power supply by opening the safety-isolating switch.
- Wait until the fans have stopped rotating before you open the inspection door (to avoid overpressure).
- Open the inspection doors of the filter/fan sections.
- Preferably vacuum clean the heat exchanger using a soft nozzle, so as not to damage the rotor surfaces. The cleaning should be carried out from the filter spaces. Rotate the rotor by hand as you vacuum clean it to reach its entire surface.
If the rotor is heavily coated with dust, blow it clean with compressed air.
- To inspect and clean the PVC-coated fabric seal: Lift up the edge of the PVC-coated fabric and check the underside. If it is in need of cleaning, turn it up over the rotor, brush it clean and then turn it back. If the PVC-coated fabric seal worn or extremely dirty, it should be replaced. Do not apply any lubrication on the fabric.
- To check the belt tension:
If the belt feels slack or worn, and if it slips whenever it meets slight resistance, get in touch with service technicians trained by Swegon.
- Check that the rotor rotates easily and as it should in the correct direction, indicated by the arrow on the label.

The rotor can be withdrawn out of the unit, if necessary. Only service technicians trained by Swegon should be allowed to do this. When the rotor is withdrawn out of the unit, it can be washed in a solution containing a degreasing agent that will not corrode its aluminium foil structure. We recommend using Swegon cleaning compound sold by Swegon Service.

9.2.4 To clean the fans

Cleaning

- Stop the air handling unit and isolate the power supply by opening the safety-isolating switch.
- Wait until the fans have stopped rotating before you open the inspection doors (to avoid overpressure).
- Open the inspection door of the filter/fan sections.
- First vacuum clean the impeller surfaces.
- Remove any dirt deposits found on the impeller blades.
- Check that the impellers aren't out of balance.
- Vacuum clean the fan motor or brush it clean. You can also clean the motor by carefully wiping it with a damp cloth that has been dipped in a solution of water and dish washing detergent.

10. TECHNICAL DATA

10.1 Dimensions

GOLD 11/12

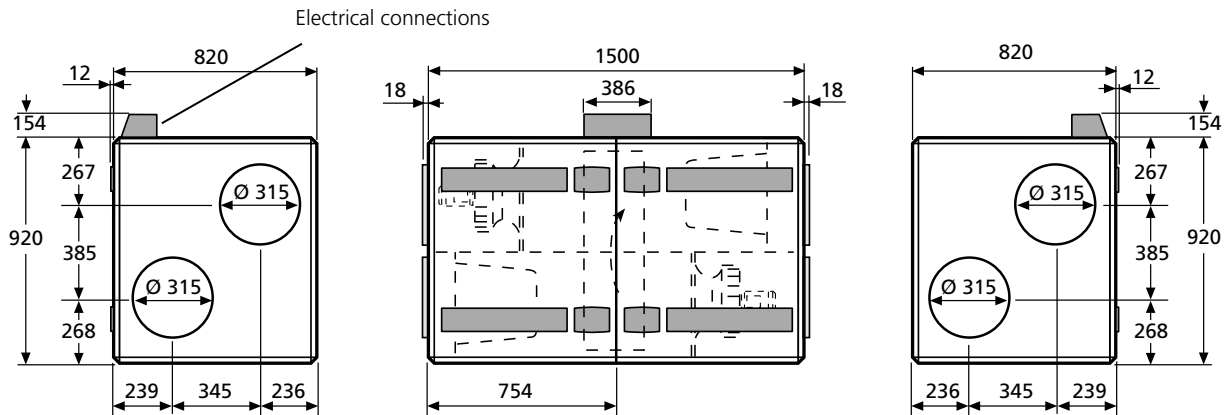

The GOLD 11/12 must be mounted on a foundation or a stand. Stands are available as accessories. Allow a clear space of at least 800 mm in front of the unit for the safety of personnel servicing electrical components.

GOLD 15

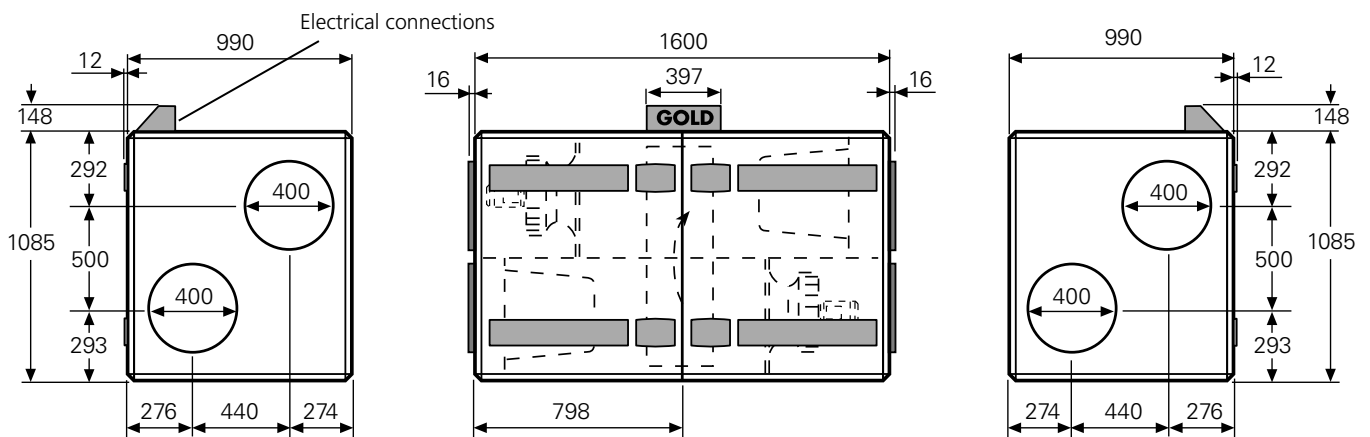

The GOLD 15 must be mounted on a foundation or a stand. Stands are available as accessories. Allow a clear space of at least 800 mm in front of the unit for the safety of personnel servicing electrical components.

10. TECHNICAL DATA

10.1 Dimensions

GOLD 21/22

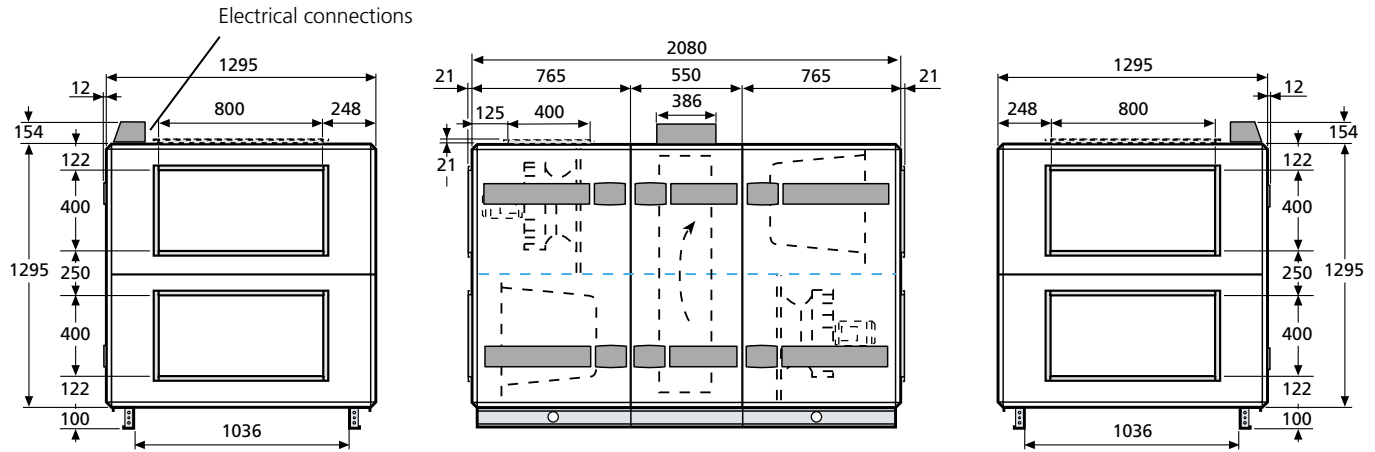

The GOLD 21/22 can be split into three sections for further transport at the building site. Allow a clear space of at least 800 mm in front of the unit for the safety of personnel servicing electrical components.

GOLD 31/32

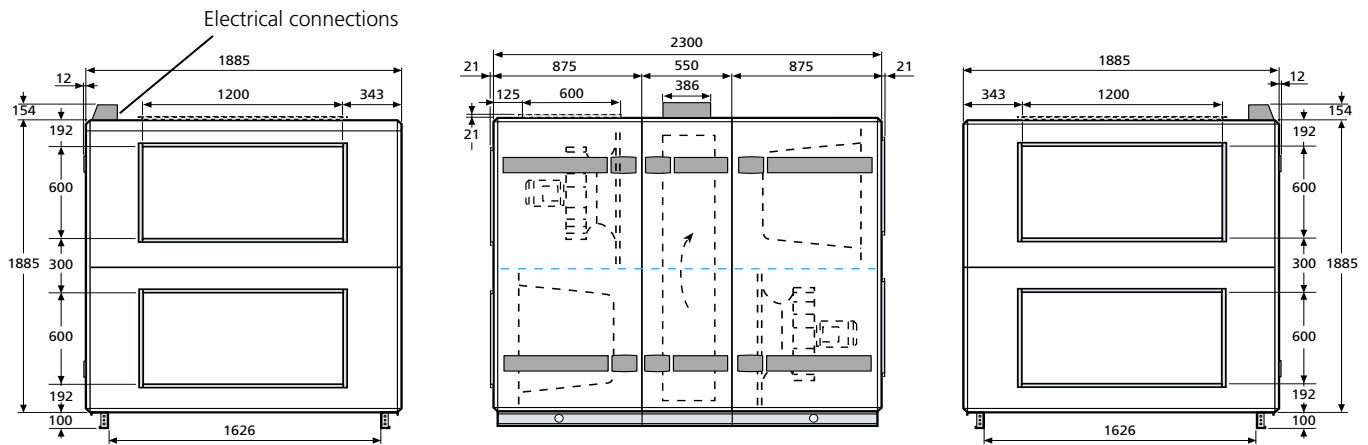

GOLD 31/32 can be split into three sections for further transport at the building site. Allow a clear space of at least 800 mm in front of the unit for the safety of personnel servicing electrical components.

10. TECHNICAL DATA

10.1 Dimensions

GOLD 42

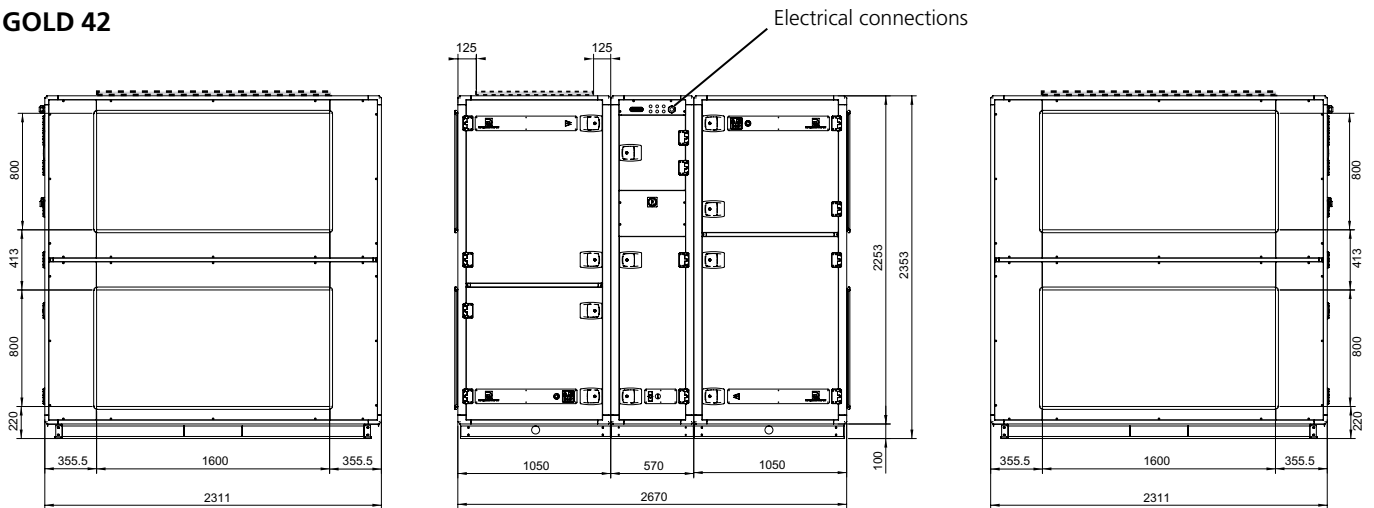

The GOLD 42 can be split into three sections for transport within the building site.
A clear space of at least 1000 mm must be provided in front of the unit to guarantee the safety of electricians servicing the unit.

GOLD 52

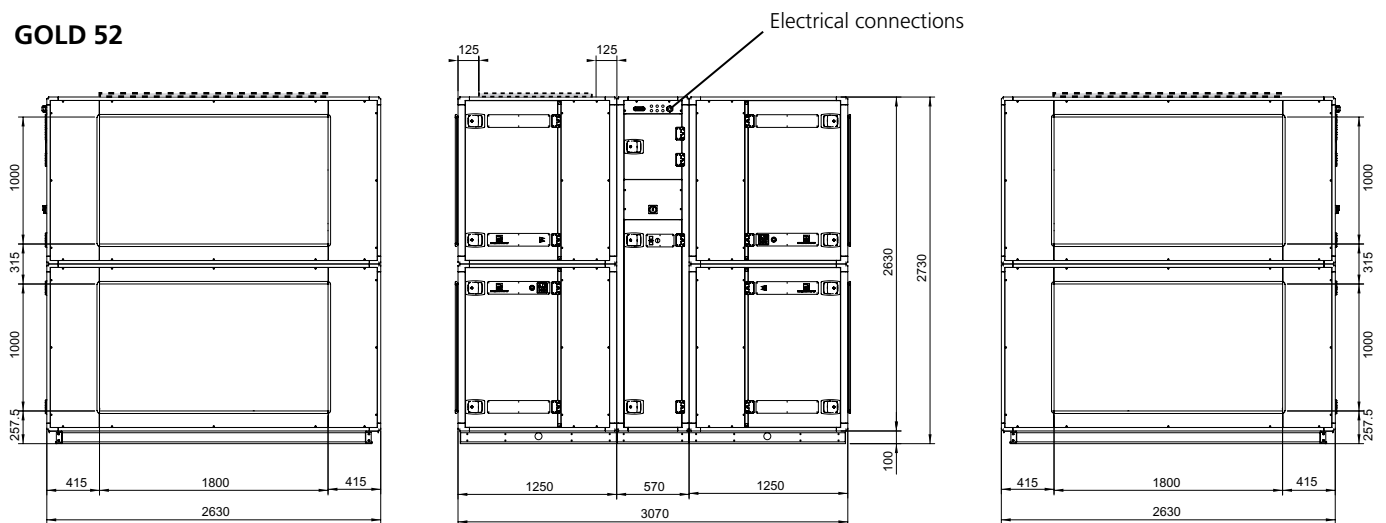

The GOLD 52 can be split into three sections for transport within the building site.
A clear space of at least 1000 mm must be provided in front of the unit to guarantee the safety of electricians servicing the unit.

10.2 Electrical Data

Air Handling Unit

The electrical connections and the external functions must be wired via the junction hood on top of the air handling unit.

CAUTION! To be carried out by a qualified electrician.

The power supply should be as follows:

GOLD 11:

1-phase, 3-conductor, 230 V \pm 10%, 50 Hz, 10 AT

3-phase, 5-conductor, 400 V \pm 10%, 50 Hz, 6 AT

GOLD 12:

1-phase, 3-conductor, 230 V \pm 10%, 50 Hz, 16 AT

3-phase, 5-conductor, 400 V \pm 10%, 50 Hz, 10 AT

GOLD 15:

1-phase, 3-conductor, 230 V \pm 10%, 50 Hz, 16 AT

3-phase, 5-conductor, 400 V \pm 10%, 50 Hz, 10 AT

GOLD 21: 3-phase, 5-conductor, 400 V \pm 10%, 50 Hz, 10 AT

GOLD 22: 3-phase, 5-conductor, 400 V \pm 10%, 50 Hz, 16 AT

GOLD 31: 3-phase, 5-conductor, 400 V \pm 10%, 50 Hz, 20 AT

GOLD 32: 3-phase, 5-conductor, 400 V \pm 10%, 50 Hz, 25 AT

GOLD 42: 3-phase, 5-conductor, 400 V \pm 10%, 50 Hz, 40 AT

GOLD 52: 3-phase, 5-conductor, 400 V \pm 10%, 50 Hz, 50 AT

Fans

GOLD 11: 3 x 230 V, 50 Hz, 0.55 kW

GOLD 12: 3 x 230 V, 50 Hz, 1.1 kW

GOLD 15: 3 x 230 V, 50 Hz, 1.1 kW

GOLD 21: 3 x 400 V, 50 Hz, 1.5 kW

GOLD 22: 3 x 400 V, 50 Hz, 2.2 kW

GOLD 31: 3 x 400 V, 50 Hz, 4.0 kW

GOLD 32: 3 x 400 V, 50 Hz, 5.5 kW

GOLD 42: 3 x 400 V, 50 Hz, 4.0 kW (Two parallel)

GOLD 52: 3 x 400 V, 50 Hz, 5.5 kW (Two parallel)

Roary heat exchanger

GOLD 11/12: Drive motor: 30 V AC. 1,5 Nm.

GOLD 15: Drive motor: 30 V AC. 2 Nm.

GOLD 21/22: Drive motor: 30 V AC. 2 Nm.

GOLD 31/32: Drive motor: 30 V AC. 2 Nm.

GOLD 42: Drive motor: 30 V AC. 6 Nm.

GOLD 52: Drive motor: 30 V AC. 6 Nm.

Electrical cubicle

Safety-isolating switches:

Sizes 11/12 25 A

Sizes 15 25 A

Sizes 21/22 25 A

Sizes 31/32 40 A

Sizes 42 63 A

Sizes 52 63 A

Fuses in the electrical cubicle inside the unit casing:

Sizes 11/12 2 fuses, 6.3 AT for control 230 V (F1 and F2, located at terminal block 201 and 202).

Sizes 15 2 fuses, 6.3 AT for control 230 V (F1 and F2, located at terminal block 201 and 202).

Sizes 21/22 Two protective motor switches 4-6.3 A (Fans in size 21 units, setting: 4.0 A) (Fans in size 22 units, setting: 5.0 A) One 1-pole, 6 A fuse (control circuit + heat exch.)

Sizes 31/32 Two protective motor switches 9-14 A (Fans in size 31 units, setting: 10 A) (Fans in size 32 units, setting: 12 A) One 1-pole, 6 A fuse (control circuit + heat exch.)

Sizes 42 Four protective motor switches 9-14 A Setting: 9 A One 1-pole, 6 A fuse (control circuit + heat exch.)

Sizes 52 Four protective motor switches 9-14 A Setting: 11 A One 1-pole, 6 A fuse (control circuit + heat exch.)

Fuses on the power circuit board in the electrical cubicle inside the air handling unit:

2 AT Control circuit: 24 V AC

Control System

The control system is completely integrated into the air handling unit. The microprocessor-based equipment controls and regulates all the motors, temperatures, air flows and other functions. A large number of functions are incorporated in the system and can easily be activated.

The air handling unit is designed to be automatically controlled between the various operating modes (stop, low speed and high speed) by means of the integrated switching clock function. The unit can also be operated manually.

Control inaccuracy:

Temperature: \pm 1°C.

Air flow: \pm 5%.

Power efficiency

The design and performance of the air handling unit enable it to meet demands on maximum permissible power-efficiency at 2.5 kW per m³s.

EMC

The air handling unit meets the provisions of the EMC Directive and has been tested in accordance with EN 50081-1 and EN 61000-6-2.

10.3 Wiring Diagram with Control Circuit Board, Size 11/12 and 15 Units

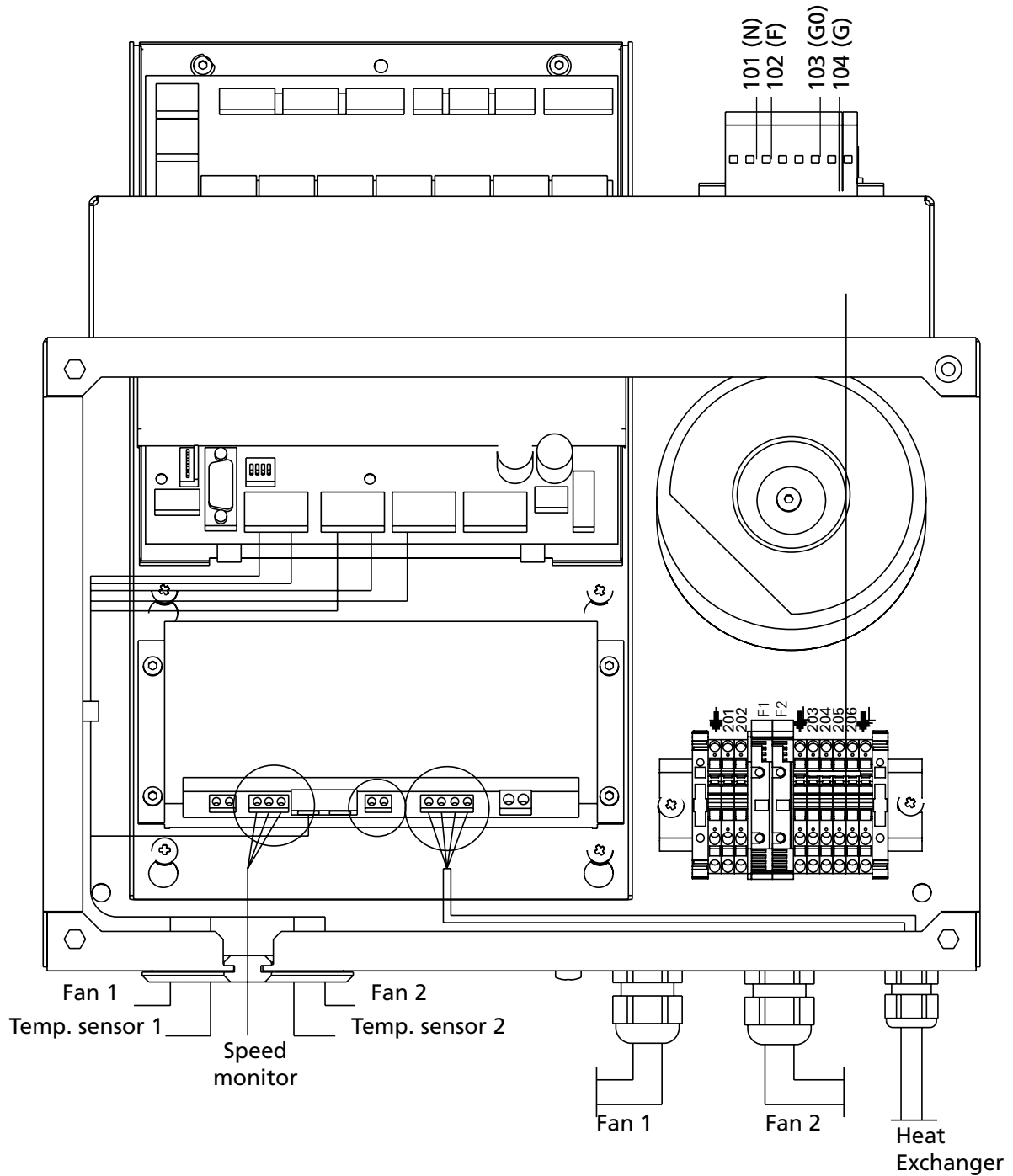

10.4 Electrical Cubicle with Control Circuit Board, etc., Size 21/32 Units

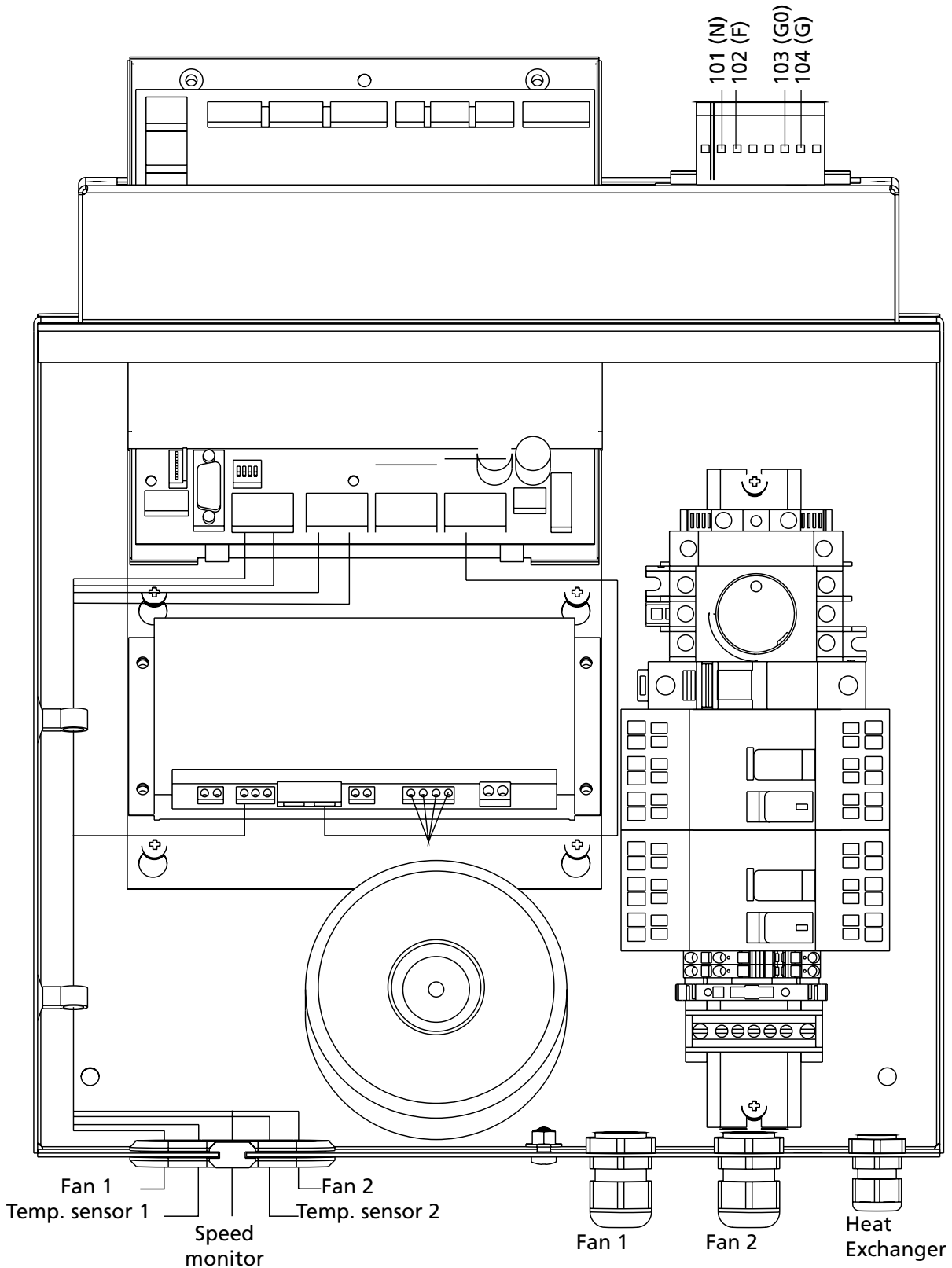

10.5 Electrical Cubicle with Control Circuit Board, etc., Size 42-52 Units

Fan arrangement 1

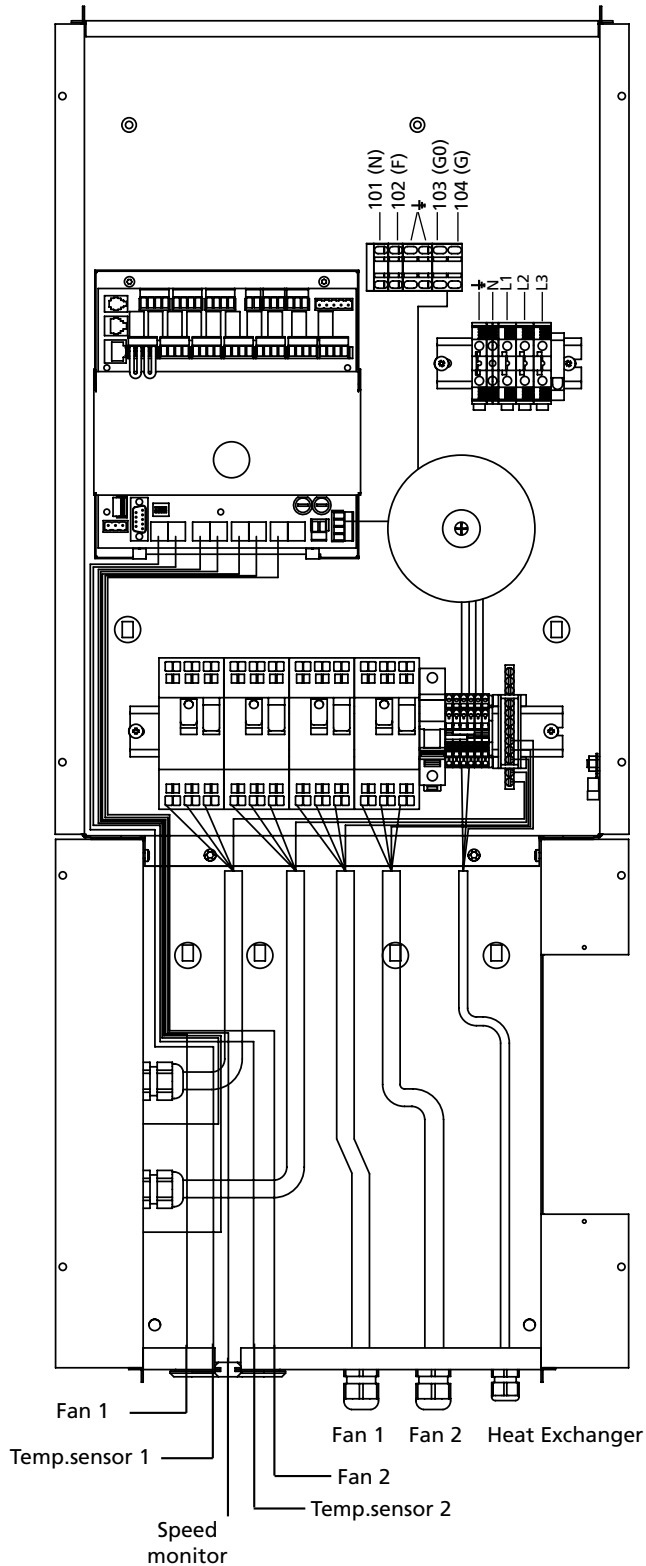

Fan arrangement2

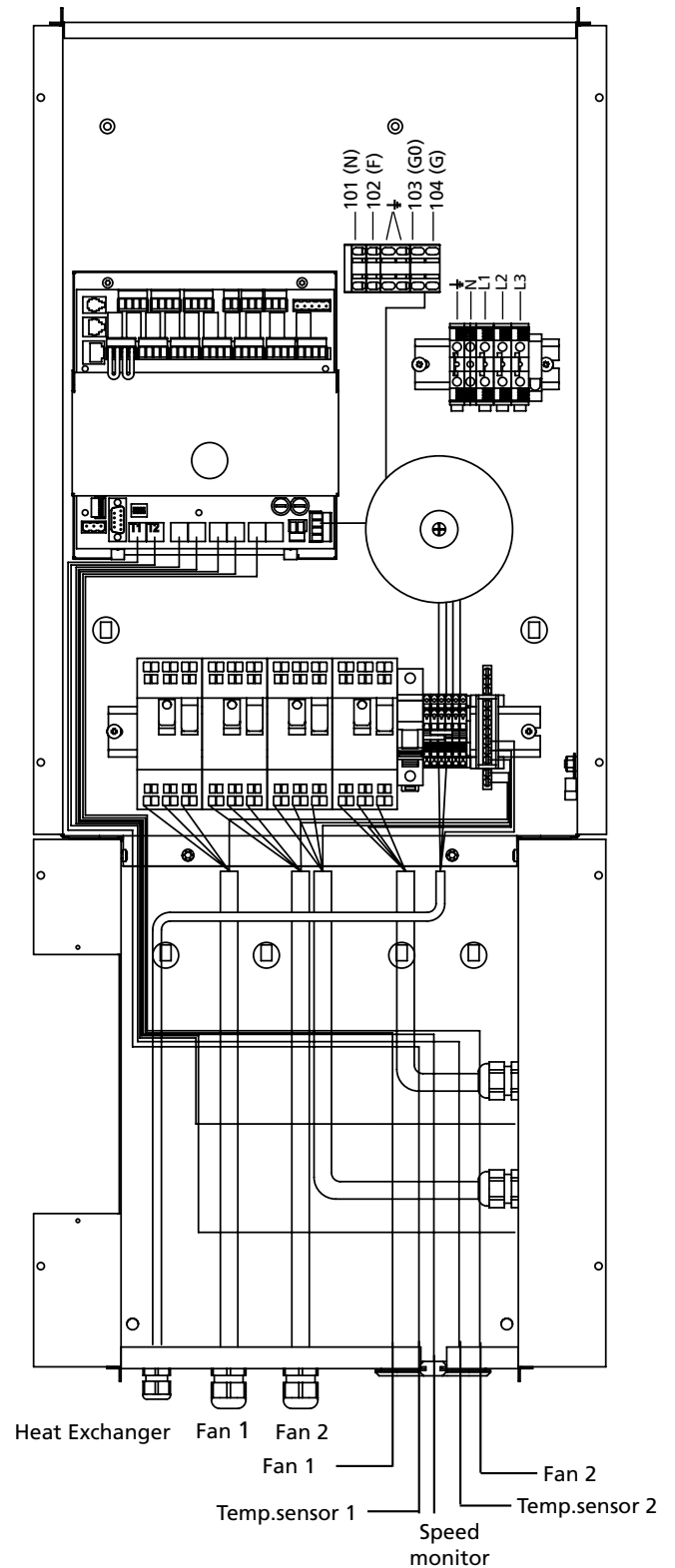

10.6 Wiring Diagram, Size 11-32 Units

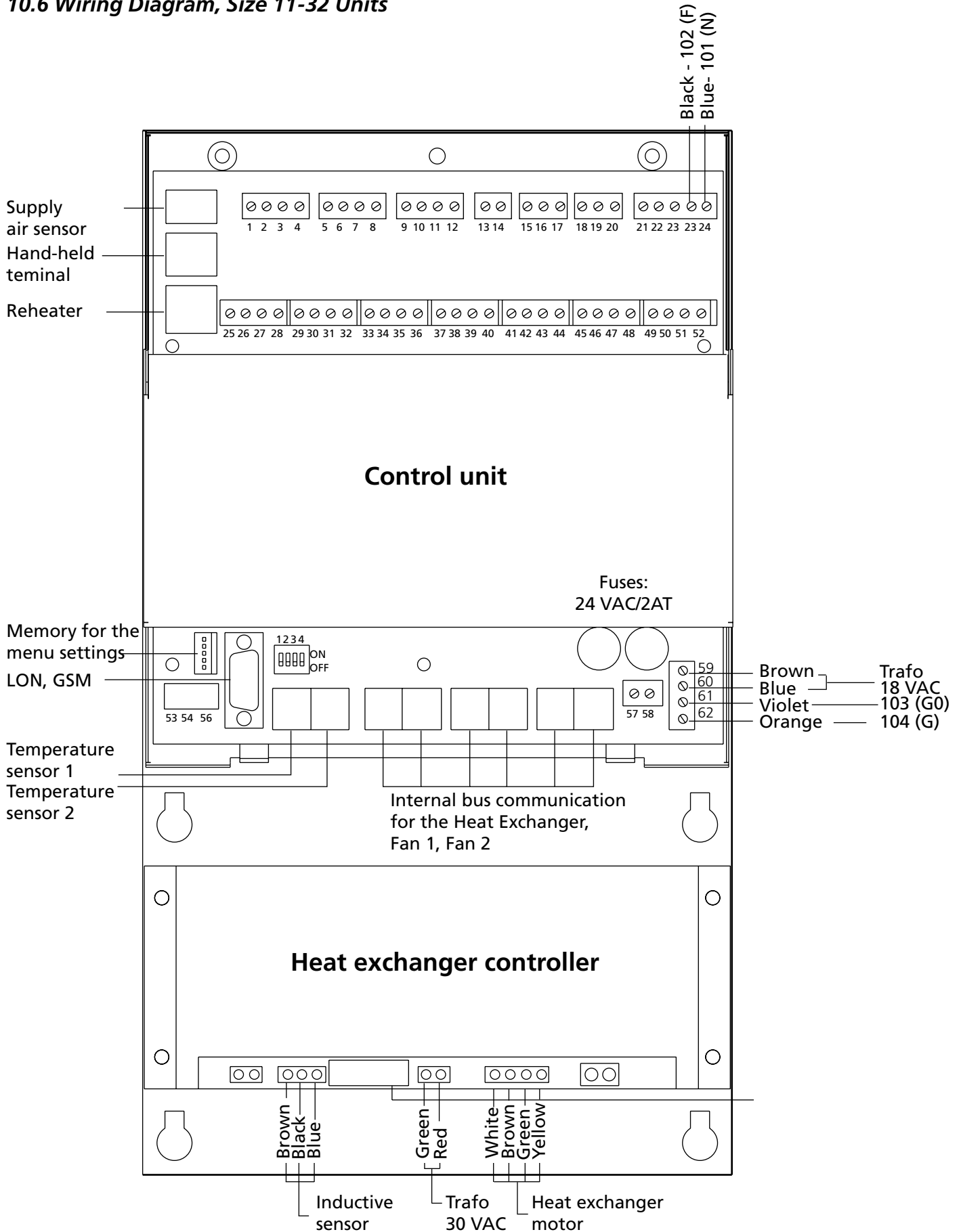

10.7 Wiring Diagram, Size 42-52 Units

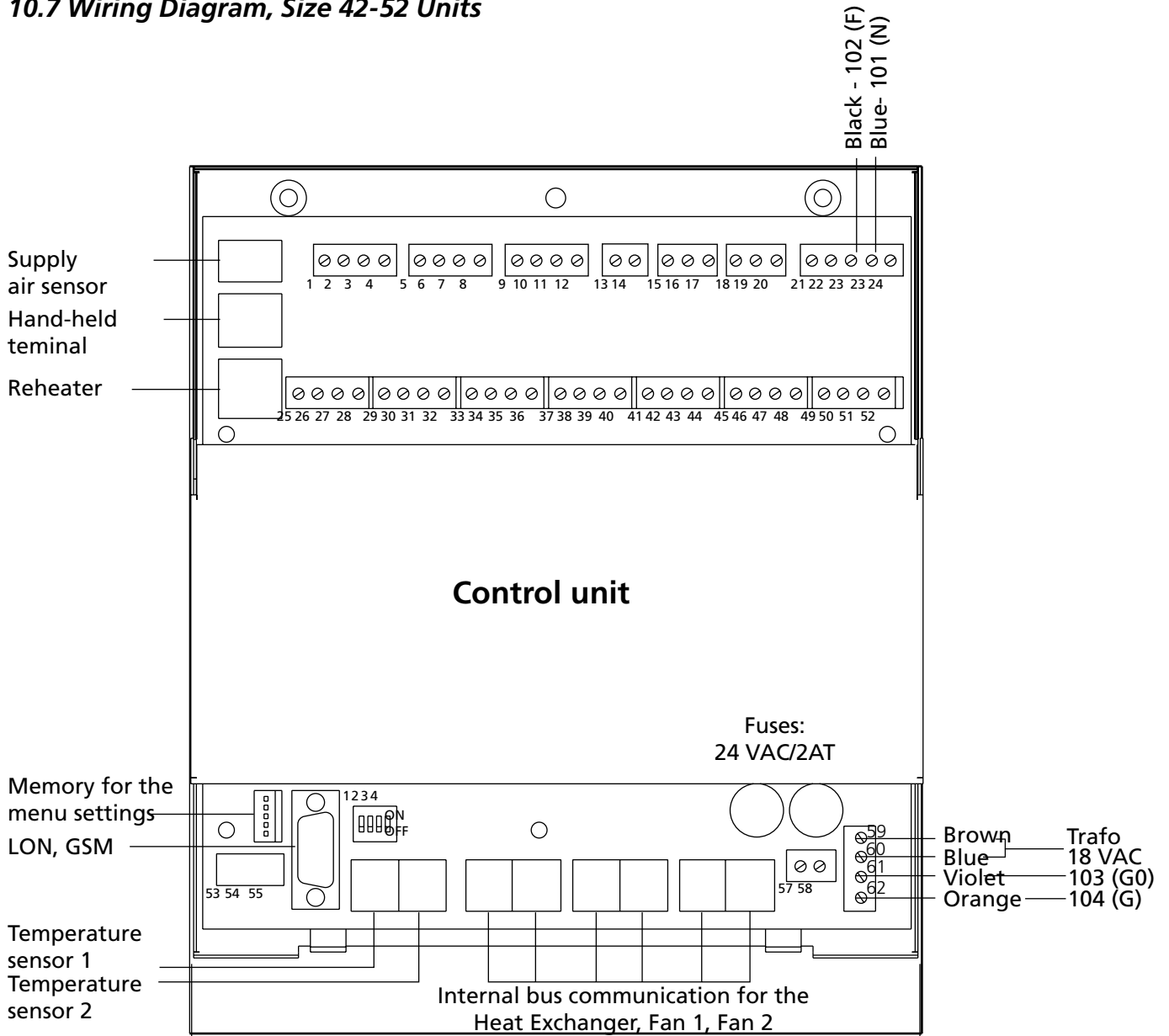

Heat Exchanger Control

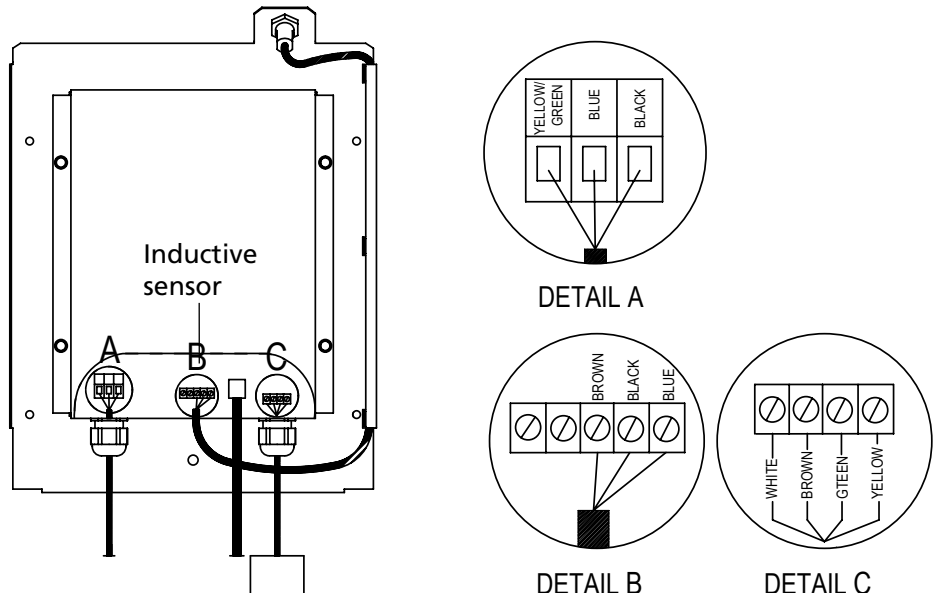

10.8 Wiring to the Terminals, Size 11-52 Units

10.8.1 Terminals in the Control System

All digital inputs (terminal block groups 25-36 and 45-46) are of extra-low voltage type.
All analogue inputs (terminal block group 47-52) have an input impedance of 66 k

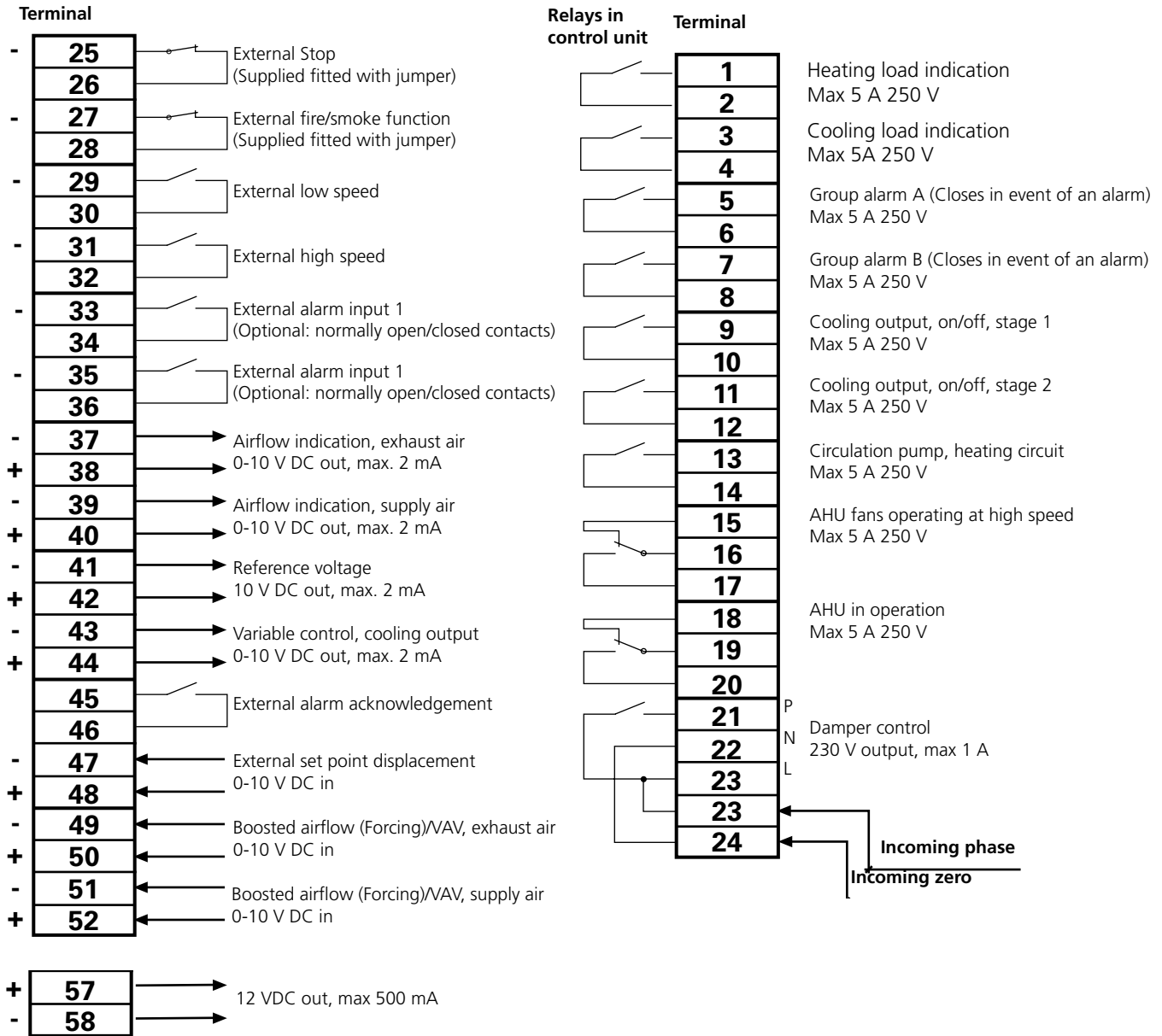

10.8.2 Terminals inside the Junction Hood

The control outputs can be opened by the safety-isolating switch. The 230 V AC output loads the power supply fuse (size 11/12 and 15 units) and the control fuse (size 21, 22, 31 and 32 units).

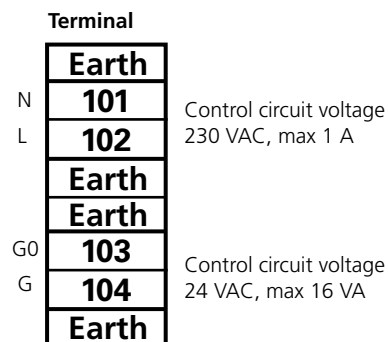

11. ASSURANCE OF COMPLIANCE

We certify on our own responsibility that the **GOLD** air handling unit that is covered by this assurance complies with the following standards: **EN 292-1.2; EN 294; EN 60204-1; EN 50081-1.2; and EN 61000-6-2**, according to the requirements of Directives **98/37/EG, 89/336/EEC and 73/23/EEC**. This assurance only applies if the unit has been installed in accordance with instructions and has not been modified in any way.