



Bilde: Hultafors

PRISLISTE | 2025

MONTASJE • VERKTØY • OPPHENG

Lagerførte varer

Lagerførte varer kan variere fra lager til lager.
Sjekk med det lageret som er nærmest deg.





Våre salgs- og leveringsbetingelser finner du [her](#).

AKRYL ACRYRUB FOR VENTILASJON					
	Acryrub er en høykvalitets-, plastoelastisk enkomponent fugemasse basert på en akryl dispersjon. Tåler temporær nedfrysing til -18° uten at massen kerner seg. Fuger med bevegelser opp til 15%. Fargeekte og vannfast etter herding. Overmalbar etter ferdig herding. Særdeles god vedheft til porøse overflater. Breeam-NOR godkjent. Svanemerket.				
	7050833	Grå	310 ml	15	52
	7050834	Hvit	310 ml	15	52

SOUDASEAL 240 FC					
	Høykvalitets 1-komponent fugemasse med høy egenstyrke. Basert på MS-polymer, kjemisk nøytral og høyelastisk. Til bruk i konstruksjonsfuger med moderat bevegelse, kompliserte overflater og i tøffe miljøer, bil, marine og luftfart eller hvor kravene til en kraftig og fleksibel lim/fuge er påkrevd. Førstevalget der det skal fuges på Plastisolplater (mykgjort PVC).				
	7050836	Svart	290 ml	12	123
	7050837	Hvit	290 ml	12	123
	7050838	Grå	290 ml	12	123











FIX ALL CRYSTAL					
	Fix All Crystal er en krystall klar, nøytral, elastisk 1-komponent lim/fugemasse basert på MS-polymer. Næringsmiddel-godkjentmiddel godkjent.				
	7050839	Klar	290 ml	12	202

FIX ALL HIGH TACK					
	Høykvalitets 1-komp. fugemasse med meget stor limstyrke. Basert på MS-Polymer. BREEAM-sertifisert iht. EC1 plus. Næringsmiddelgodkjent. RATT-merket.				
	7050842	Grå	290 ml	12	203
	7050843	Alum.grå	290 ml	12	203
	7050846	Lys grå	290 ml	12	203
	7050844	Hvit	290 ml	12	203
	7050845	Svart	290 ml	12	203

SOUDAFOAM FLEXIBLE INSULATION FOAM					
	Et en-komponent ekspanderende polyuretanskum som er behagelig og enkel å bruke med Soudals patenterte GeniusGun adapter. Bruksområde -10 gr til +30 gr				
	7050841		600 ml	12	225

A95 ACRYL FOR VENT. KANALER					
	Vannbasert, overmalingsbar, klebefri etter 30 min, herdet på 1 døgn, lydreduserende				
	7050835	Grå	5 liter	1	1 010

	SWIPEX RENSEKLUTER	7050831		100 kluter	206
	HOLDER TIL RENSEKLUTER	7050832			333
	SPRAYMAX 1K - Utbedringslakk	7050853	Lysgrå		655
	SPRAYLIM	7050852	Klar	500 ml	334
	COLORSPRAY RAL 9003	7050856	Hvit	400 ml	615
	COLORSPRAY RAL 9005	7050857	Svart	400 ml	242
	COLORSPRAY RAL 9005 MATT	7050858	Svart	400 ml	251
	SILIKONSPRAY	7050855		400 ml	119
	GLIDEX	7050630		1 kg	1 260
	UNIVERSALSPRAY - ALL IN ONE	7050854		300 ml	189

RADIATORPENSEL					
	Av ren svart bust. Langt skaft				
	7050859		40 ml		55
PROFF FUGESPRØYTE					
	Dryppfri toppmodell				
	7050860		300 ml		530
PVC-TAPE					
	7050861	Grå	48 mm	20 m	70,- /stk.
BYGGTAPE					
	Diffusjonstett tape for å oppnå høyere tetthet i nye bygg. Benyttes rundt tettemansjetter.				
	7050863	Grønn	60 mm	25 m	535,- /stk.
POLYPROPYLENTAPE 907-AC					
	Liten diameter, passer i lommen. Sølvfarget, uten armering				
	7050862		75 mm	64	89,- /stk.
ISOLERINGSTAPE NASHUA 365 TAPE					
	Forsegling av lamellmatter. Diffusjonstett. 55 meter.				
	7050864		72mm x 55m	16	575,- /stk.
PROTECT BLACK TAPE					
	7053979		90mm x 100m	12x	4 190
VVS-TAPE					
	Ubrennbar, uarmert og diffusjonstett alu-tape for bedre feste av lamellmatte. Når rutemønstret fra underlaget vises gjennom tapen har du fått riktig tilllutning. 50 meter.				
	7050865		75 mm	16x	335
TETNINGSLIST PE					
	7050851		10x6mmx10m	Pkn. 5 ruller=50m	1 010
VULKTAPE M/ALUFOLIE					
	Kraftig "selvulkaniserende" tetningstape spesielt godt egnet for sirkulære kanaler og tetting av kanaler lagt i grunn. 15 meter.				
	7050869		75 mm		1 080

KRYMPETAPE-NITTO NW1250					
	Tapen har utmerket kjemisk motstandskraft, og er lett å legge på. Den har også gode vanntette egenskaper. Kan krympes med varmluft eller åpen flamme. Tapen har god UV-bestandighet.				
	Materiale	Polyetylen Mastic Butylgummi	Høyeste driftstemperatur	+90 °C	
	Tykkelse inkl. folie	1 mm	Krympetemperatur	+120 °C	
	Krymping	50 %	Farge	Sort	
	Strekkeholdfasthet	19 kg/20 mm ²			
7050867		100 mm	10 meter lang		1 340
MANSJETT PÅ RULL					
	7050870	25 meter	35/60/35 mm		61,- /pr. m
WATERSTOP SVELLEBAND					
	Benyttes i plastøppte konstruksjoner. Båndet legges rundt rør el. innstøpningsmuffe og blir støpt inn.				
	7050850	25x25mm	1-5 m	Krt. 6x5m	2 730,-/rull
VIBRASJONSMATTE - DOBBEL					
	ART.NR	DIM		PRIS	
	7051031	B: 500 L: 600 H: 8,0		2 470	
PROTEGA ECOMASTIC SP					
	Er en hvit, elastisk og halogenfri acryl brannfugemasse, som benyttes til branntetting av vent.kanaler i gjennomføringer i brannklassifiserte bygningeslde. Benyttes også til liming av brannskiver. Godkjenning: ETA 17/0767 - ETA 17/0764. Brannklasse: EI60-EI120 Miljøsertifisering: Byggvarubedømmingen, Sunda Hus, Basta - Svanemerket				
	7053672	Fugeposisjon: To-sidig	Fugedybde: 25 mm	Fugebredde: maks 15 mm	krt. 12
PROTEGA BRANNSKIVE ECOMASTIC-1					
	Er en steinullskive ensidig belagt med brannmaling. Benyttes til tetting av rør- kabel- og ventilasjonsgjennomføringer. Densitet: 150 kg/m ³ . Godkjenning: ETA 17/0767. Brannklasse: Opptil EI 120. Miljøsertifisering: Byggvarubedømmingen, Sunda Hus, Basta - Svanemerket				
	7050847	Tykkelse: 60	Dim: 1200x600		1 070
PROTEGA SUPERWOOL					
	Er en mineralullmatte/remse som benyttes som bunnfylling ved branntetting. Fungerer også som lyd-demping. Densitet: 96 kg/m ³ . 7300 mm remse i kartong gjør det enkelt å skjære og forme.				
	7050848			BxL: 100x7300	1 220
BRANNTETTING ETIKETT					
	Dokumentasjon av branntetting. Etikett på rull 60x100mm. 25 stk r rull.				
	7050849			Rull krt: 10x	291
GLAVA GPG BRANNMASSE					
	Mørtel for branntetting rundt kanal- rør- og kabelgjennomføring, samt tetting av fuger og åpninger mellom brannceller. Volumutvidelse 1%.				
	7051303			20 liter bøtte	1 650

BLINDNAGLER						
	Stål	7050876	3,2x8 mm	500x		328
	Rustfri	7050877	3,2x9 mm	500x		780
	Stål SVART	7050879	3,2x10 mm	500x		1 540

SELVKLEBENDE LIMPINNER						
Inkl skive. Ikke anbefalt til tyngre matter.						
		7050880	32 mm	100x		5 /stk
		7050881	55 mm	100x		6 /stk

ISOLERINGSSKRUER						
		7050893	4,8x50 BOR	500x		2 /stk
		7050894	4,8x70 BOR	500x		3 /stk
) sekskantet hode	7050895	4,8x60 BOR)	500x		3 /stk
) sekskantet hode	7050896	4,8x100 BOR)	250X		4 /stk

ISOLERINGSSKIVER						
		7050897	80 mm	250x		10 /stk
		7050899	40 mm	250x		2 /stk

FARMERSKRUER						
Borspiss med høy kapasitet. Høy uttrekks-kraft EPDM-pakning.						
		7050882	4,9x20 mm	Svart		2 /stk
		7050886	4,9x20 mm	Lysgrå		2 /stk
		7050884	4,9x20 mm	Hvit		2 /stk
		7050883	4,9x35 mm	Svart		2 /stk
		7050885	4,9x35 mm	Hvit		2 /stk
		7050887	4,9x35 mm	Lysgrå		2 /stk
		7050888	4,9x60 mm	Blank		4 /stk

BYGGSKRUE M. PAKNING						
	Forz.	7050889	6,5x38 mm	250x		5 /stk
	Forz.	7050890	6,5x64 mm	150x		6 /stk



TAKRENNESKRUE						
		7050892	4,9	100x		2 /stk

UNISPEED							
Ventilasjons skrue med skarp spiss for spiro-montasje. Oppfyller kravene til tetthetsklasse D. Korr. klasse C1. Benytt Unite mag.holder pga hodehøyde.							
	U51	7053949	Dim: 4,2x9,5	Ansl ¼"	Kap: 2x0,9	1000x	500
	U52	7053948	Dim: 4,2x13	Ansl ¼"	Kap: 2x0,9	5000x	2 470
	U52-05A - RAL 9003	7053946	Dim: 4,2x13	Ansl ¼"	Kap: 2x0,9	1000x	1 480

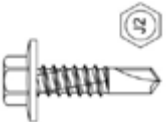
UNIVENT							
Ventilasjonsskrue med redusert borspiss. Oppfyller kravene til Tetthetsklasse D.							
	U42	7053947	Dim: 4,2x13	Ansl 1/4"	Kap: 2x1,0	1000x	443

SUPERTEX SKRUE							
Borrende skrue med sekskanthode og flens.							
		7050917	4,8x19	250x			287

BYGGSKRUER FOR UTENDØRS BRUK C4							
Høykvalitet rustfri (A2) skrue med tetning og Torx 25 (T25) spor med effektivt borskjær. Brukes til rustfritt arbeid.							
		7050902	4,8x19 (rustfri)	250x			1 750
		7050918	Bits FR-Tool - Plast				98
		7050904	4,9x35 rustfri (RAL 9006)	50x			510

WALL-DOG							
Skruer til allround montering. Fin til gips, tre samt også betong om du forborer med 4 mm.							
	Krom	7050948	6,5x32	100x			6 /stk.
	Hvit	7050949	6,5x32	100x			6 /stk.
Retningsgiv. verdier:		Materiale		Uttrekk/bruddlast			
		Gipsplate 12 med mer		0,4 kN			
		Betong C25		2,0 kN		29 mm inn	
		Teglestein		0,6 kN		29 mm inn	
		Murstein		1,0 kN		29 mm inn	

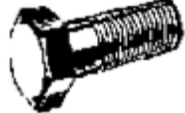
SEKSKANTSKRUER 8,8 HG							
		7050922	M8x20	100x			4 /stk.
		7050923	M8x30	100x			5 /stk.
		7050924	M10x30	100x			16 /stk.

SKINNE SKIVER 40MM							
		7050934	M 6	100x			2 /stk.
		7050935	M 8	100x			25 /stk.
		7050936	M10	100x			25 /stk.

FLENSMUTTER DIN 6923							
		7050931	M 6	100x			3 /stk.
		7050932	M 8	100x			4 /stk.
		7050933	M10	100x			5 /stk.

SPIKERPLUGG TIL LETTERE INNFESTING

	7050937	5x40	100x	2	/stk.
	7050938	6x50	75x	2	/stk.
	7050939	6x60	75x	2	/stk.
	7050940	8x60	40x	4	/stk.
	7050941	8x100	25x	4	/stk.

KILESPIKER DN 6/35

	7050962	6x35	100x	435	pk

EKSPANSJONSBOLTER

Elforsinket. Kan også leveres i syrefast og varmforsinket materiale.

	7050942	8x50	100x	10	/stk.
	7050943	8x75	50x	14	/stk.
	7050944	10x60	50x	16	/stk.
	7050945	10x32	25x	23	/stk.
	7050946	10x134	25x	33	/stk.
Brannklasse					
	Dim	Brannteknisk klasse	Minste monteringsdybde - mm	Karakteristisk bærelast kN	
	M8	R 90	35	0,5	
	M8	R 60	35	1,0	
	M10	R 60	40	1,5	
	M10	R 60	80	2,0	

KRUGE VIPPEBOLTER

Med den formonterte vippebolten, er det mulig å montere rør rett opp i korrugerte stålplater.

	7050963	8x100		62	/stk.
	7050964	M8x200		70	/stk.
	7053975	M10x100		74	/stk.
	7050965	M10x200		86	/stk.
	Arbeidslast vippebolt		Hull-Ø		
0,8 kN		22			

GIPSANKER (MOLLY)

For montasje i gips av brannspjeld, konsoller m.v. Benytt monteringsverktøy for riktig montasje. Skrue dim. M6

	Type	Art.nr	Gips tykkelse	Maks tykk. objekt	Forpagn.	Pris
	M21-6E	7053950	8-16	20 mm enkel gips	50x	740
	M21-6D	7053951	22-30	21 mm dbl. gips	50x	810
	M2191	7053952		Montasjeverktøy		530

SLAGANKER MED KRAVE

Gir skjult forankring av gjengstag i betong eller stein. Ekspansjonen er kontrollert med en spesialdor for å oppnå riktige lastverdier. Brannklassifisert.

	7050953			4	/stk.
	7050954	M 8	100x	5	/stk.
	7050955	M 10	50x	7	/stk.
Monteringsdata		Tillatt last - Betong C20/25			
	Beskrivelse	Bordybde	Uttrekk kN	Skjær kN	
	M8	30	3,6	3,1	
	M10	40	4,8	4,5	

SLAGDOR						
	7050957	M8			179	/stk.
	7050958	M10			236	/stk.

SLAGANKER VERKTØY						
For rask og effektiv montasje av slaganker. NB! Bor er 10m/m						
	7050959	M8x30			770	/stk
	7050960*	M8			920	/stk
*Borsats til slaganker-verktøy						

NØKKELANKER						
Spesialfeste i betong for oppheng av kanaler. OBS! Fjærstål! Ingen brannklassifisering. Frarådes brukt iflg. forskrifter.						
	7050961		90x		535	/pk

FASADEPLUGG						
Benyttes i alle materialer korr. Klasse C3. Diam: 10 Lengde: 100 Hull: 10 Montasjedybde: 70"						
	7050951		50x		27	/stk

BLADHYLSE						
For gjengestag ved pendelmontasje						
	Max. Last: 2,6 kN	7051018	M 8		4	/stk.

LANGMUTTER						
	7051019	M6			3	/stk.
	7053677	M8			5	/stk.

GIPSPLATEPLUGG DRIVA						
	7050952		100x/pk		6	/stk.

BETONGSKRUE M/PANHODE BSZ-LK						
Brannklassifisert R30-R120						
		Art.nr	Type	Bordia	Ant. pk	Pris
	Torx T30	7051082	5,0x40	5	100	10
Torx T30	7050947	6,0x40	6	100	18	



BETONGSKRUE

Med innv.gjenge M8/M10 el. forz

	Art.nr	Type	Bordia.	Nøkkelvidde	Ant. pk	Pris	
	7051086	6x35	6	13	50x	30	/stk.

Godkjennelse ETA-16/0655 og ETA-16/0656.
 Montering: Forbor med ø6mm. Fjern smuss. Skru inn skruen, taggene ytterst på gjengene skjærer gjengespor. Arbeidslast i C25/30-betong tak 1 OKN, sikkerhetsfaktor iht. ETAG 001.

VERTIGO TIL TRE

 	Art.nr	Type	Lengde	Pris	
	7051087	M8	100x	25	/stk.
7051088	M10	100x	25	/stk.	

Vertigo 

WAFER TRESKRUE MED SKIVEHODE

	Art.nr	Type	Hode ø-mm	BITS	Ant. pk	Pris	
	7050900	8x60	21	Torx 40	50x	7	/stk.
	7050901	8x100	21	Torx 40	50x	9	/stk.

Bruksområde: Spesielt egnet til rask og sikker innfesting av konsoller, montrasjeskinner og andre detaljer til tak og vegger av massiv tre, limtre og andre konstruksjoner i tre.
Beskrivelse: Høy belastningsoverføringsevne takket være det store skivehodet.
Materiale: Herdet kullstål med C4-klassifisert ytterbehandling. Spiss med skjærekant.

POP-BOR					
Spesialbor for stålplater. Unik kvalitet!					
	7050970	3,3	10x		36

BOR-KASSETT 1-10 HSS					
	7050969				545

HULLSAGSETT MX FOR VENTILASJON					
		FARGE	ART.NR	BRUKSOMRÅDE	
	57-111-133-168-210	Orange	7050983	Betong, tre	8 510
	57-111-133-168-210	Hvit M42	7050986	Metall, gips (himling)	6 950
Høykvalitets hullsagsett fra Mandrex 5X raskere en tradisjonelle hullsager pga hardmetallskjær. Disse hullsagene sager i PVC, Fliser, Murstein, leca, treverk. Raskt bytte av hullsager med Snaplock skiftet, kuttedybde 51 mm. Settet leveres med holder for bor + bor for Leca					

MANDREX HULLSAGER FOR VENT.KANALER, BIMETALL					
	Hullsag for vippebolt	7050973	22 mm		146
	Hullsag - Mandrex	7050974	111 mm		705
	Hullsag - Mandrex	7050975	133 mm		1 410
	Hullsag - Mandrex	7050976	168 mm		2 100
	Hullsag - Mandrex	7050977	210 mm		3 040
	Hullsag	7051036	256 mm		3 080
	Hullsagholder A-2	7050978			585
	Senterbor for hullsag (gml. type)	7050979			136
	Holder til 22mm	7050972			215
	Hullsagholder - Mandrex - 11mm	7050980	Chuck 11 mm		660
	Hullsagforlenger 11x300	7050981			242
	Mandrex hullsagbor HSS	7050982			123
	Mandrex hullsagbor betong	7050984			123
	Hullsagholder SDS+ Mandrex	7050985	SDS+		820

SDS + HAMMERBOR NEMESIS - 4-skjærs kvalitetsborr					
	Lengde: 160 mm	7050994	6,5		263
	Lengde: 110 mm	7050987	5		157
	Lengde: 110 mm	7050988	6		136
	Lengde: 160 mm	7050989	6		297
	Lengde: 110 mm	7050990	8		162
	Lengde: 160 mm	7050991	8		314
	Lengde: 160 mm	7050992	10		341
	Lengde: 160 mm	7050993	12		349

NEMESIS BORSETT SDS-PLUS - 4-skjærs bor 7 deler					
		7050995			1 640
	ø5x110, 6x110, 6x160, 8x110, 8x160, 10x160, 12x160				

GJENGESTAGKUTTER HIT M8/M10

	GJENGESTAGKUTTER	7051157	M8/M10		6 730	
	RES.SKJÆR GJ.STAGKUTTER	7051158	M8		675	
		7051159	M10		675	

STEGLØST BORSETT

	7050971				3 520	

DEKKRINGER HVIT PLAST

Dekker alle stygge utsparinger der kanalen går gjennom veggen. Spesielt gips.

	Art.nr	Dim.	Bredde flens	Pris	
	7051010	100	25 mm	128	
	7051011	125	30 mm	144	
	7051012	160	30 mm	160	
	7051013	200	40 mm	185	
	7051014	250	40 mm	205	
	7051015	315	40 mm	246	
	7051016	400	50 mm	308	
	7051017	500	50 mm	710	

KAPPEKIVER UTGAVER FOR SPIRO

	7051045	125	50x	59	/stk.



OPPHENGSBÅND						
	Slette. 25 meter	7051032	19mmx0,7		268	/rl.
	Kraftig utgave. 25 meter	7051034	25mmx0,9		398	/rl.
	Hullet. 25 meter	7051033	16mmx0,9		289	/rl.
	Hullet. 25 meter	7051035	20mmx0,7		285	/rl.

GJENGESTIFT						
	7051040	M8x25	100x		7	/stk
	7051041	M8x40	100x		4	/stk

GJENGESTAG 4,6 FZB						
Leveres i 2 meters lgd. Bunter à 25 stk						
	M 6	7051118			28	/stk
	M 8	7051119	E130	5,0 kN	50	/stk
	M 10	7053680	E160	7,5 kN	78	/stk
	M 12	7051121	E160	8,0 kN	59	/stk

RILLEDE GJENGESTAG						
Riller pr. 10 mm						
	M 8	7051085			223	

KOMBISKRUER						
	7051037	M8x50	100x		8	/stk
	7051038	M8x70	100x		7	/stk
	7051039	M8x100	100x		16	/stk
	7051042	M10x80	100x		9	/stk

SKINNE 41/21						
	7051092	Skinne 41/21 - 1.5 - 2meter - Pregalv			650	/stk
	7051091	Skinne 27/15/1,25 - 2meter - Pregalv			475	/stk
	7051089	Skinnemutter M8 m/fjærskive			69	
	7051090	Skinnebolt H29 M8x20			169	
	7051094	Klikkfeste M8 m/låseplate PHB41ELZ			120	
						

SPIROKLAMMER

For sirkulære kanaler. For innfesting til tak med pendel el. gjengestag, utstyrt med bladhylse eller L-jern. Hull Ømm: 10,5

	7050998	315x	30x1,50	36	/stk
	7050999	400x	30x2,00	55	/stk
	7051000	500x	30x2,00	67	/stk
	7051001	630x	30x2,00	84	/stk

VENTILASJONSKLAMMER M8/M10 WHITELINE

Hvite: RAL 9003

	7052687	100	50x	51	/stk
	7052688	125	25x	59	/stk
	7052689	160	25x	68	/stk
	7052690	200	25x	74	/stk
	7052691	250	10x	83	/stk
	7052692	315	10x	96	/stk
	7052693	400	10x	116	/stk

PROCLAMP VENT. R60

Et to-delt skrukammer med M8 og M10 anslutningsmutter, for oppheng av spirorør. Klammerboltene er formontert på klammeret. Hekte-ordning på klammerets åpne side. Brannklassifisert.

	Art.nr	Utv. diameter (mm)	Ant/pk (stk)	Pris	
	7051047	100	50x	41	/stk
7050015	125	25x	46	/stk	
7051048	160	25x	53	/stk	
7051049	200	25x	61	/stk	
7050016	250	10x	116	/stk	
7051050	315	10x	146	/stk	
7051051	400	10x	187	/stk	
7051052	500	10x	228	/stk	
7051053	630	10x	274	/stk	

 Dokumentasjon R60 godkjenning gjelder fom ø100 tom. ø500
 KIWA testrapport 3000-21-100949.

Beskrivelse

 ProClamp Vent. tilfredsstillende kravspesifikasjonene iht. NS-EN 1366-1: 2014 + A1.
 Prøving av brannmotstand til tekniske installasjoner. Del 1: Ventilasjonkanaler.

Materiale: Stål DC01 iht. EN 10130, elektroforsinket 12 Pm (my)

Montering

 Leveres med 10 mm sekskantskrue med krysspør for enklere montering.
 Boltene trekkes til med maks 2 Nm. c/c avstand se tabell med isolering



	Dimensjonsområde (mm)	Materiale	Maks tillatt arb. last kN	Ansl.
	100 - 200	20x1,5	0,8	M8/M10
	250-400	20x1,5	1,0	M8/M10
	450-630	25x2x0	1,0	M8/M10

VUGGER				
For sirkulære kanaler. Kan benyttes- dels som vugge for oppheng av kanaler, da festet til tak med eks. 2 stk. gjengestag, eller som todelt klemmer med enkel eller dobbel innfesting. EI-60 brannklassifisert. Hull Ømm: 10,5				
	7051002	30x1,5	250	18 /stk
	7051003	30x1,5	315	21 /stk
	7051004	30x2,0	400	31 /stk
	7051005	30x2,0	500	38 /stk
	7051006	30x2,0	630	44 /stk
	7051007	30x3,0	800	82 /stk
	7051008	30x3,0	1000	100 /stk
	7051009	30x3,0	1250	126 /stk
	7052694	Hvit RAL9003	315	107 /stk
	7052695	Hvit RAL9003	400	147 /stk
	7052696	Hvit RAL9003	500	173 /stk

BRANNKLASSIFISERTE OPPHENG

Når det er krav til brannmotstand for opphenget, må opphengsløsning og avstanden mellom oppheng velges slik at tyngden av installasjonen (kanal inkl. isolering) ikke belaster hvert innfestingspunkt med mer enn 0,5 kN når kravet er brannmotstand R-15 1,0 kN når kravet er brannmotstand R-30 eller R-60

GRUNNPLATE				
For feste til tak, vegg og gulv. Uttrekkslast: 1,5 kN				
	7051075	M8/10	100	19 /stk

GEIDERKLAMMER				
For tilstramming av geid. Påmontert M8x20 strue. Tilstramming max 7Nm.				
	7051081		200 stk	14 /stk

KANALFESTE M/LYDABS.				
	7051028	M8/10		152

BJELKEKLAMMER				
Arb.last TCS 0:3,5 kN Arb.last TCSII: 8,5 kN				
	7053678	M8/10		278

SMARTOPPHENG				
	7051024	M8		16

MONTASJEVINKEL

Ypperlig for bl.a innfesting av bokser og ventiler over himling 20-pkn

	7051025	590x50x30	20		1 520	
	7051026	590x50x50	20		1 610	

GUMMIDEMPERE

			Kap. max: 300 kg			
	Understøttelse til bl.a aggregat	Ø75 h=35	7051030			341

L-JERN/Z-JERN

		7051023	83x33x2,5	100x/pk	54	/stk
		7051027	53x33x36x2,5	100x/pk	52	/stk

TRAPEZHENGER

For gjengestag

		7051076	M8		35	
		7051077	m/hull	Ø8/10	16	

OPPHENGSmateriell for korrosive miljøer

VENTILASJONSKLAMMER M8/M10 PROCLAMP - AISI 316 SYREFAST TO-DELT					
	7051057	125	25x		297 /stk
	7051058	160	25x		320 /stk
	7051059	200	25x		389 /stk
	7051060	250	10x		600 /stk
	7051061	315	10x		685 /stk
	7051062	400	10x		800 /stk
	7051063	500	10x		1 020 /stk

VENTILASJONSKLAMMER SYREFAST 1:4404					
M8/10 Påmontert dempegummi. Benyttes til kanalmontasje syrefast og Magnelis.					
	7052471	125	1,8x20	60x	175 /stk
	7052472	160	1,8x20	60x	214 /stk
	7052473	200	1,8x20	40x	251 /stk
	7052474	250	1,8x20	40x	316 /stk
	7052475	315	1,8x20	30x	360 /stk
	7052476	400	1,8x20	30x	476 /stk

MAGNELIS ZM310 HELKLAMMER					
	ART.NR	DIM	MATR	FORPAK.	PRIS
	7053675	102	1,25x30	10	53
	7050081	127	1,25x30	10	54
	7050082	1362	1,50x30	10	56
	7050083	202	1,50x30	10	62
	7050084	252	1,50x30	10	73
	7050085	318	1,50x30	10	92
	7050086	403	2,0x30	10	142
	7050087	503	2,0x30	10	175
7050088	633	2,0x30	10	217	

MAGNELIS ZM310 VUGGE					
	ART.NR	DIM	MATR	FORPAK.	PRIS
	7050074	403	2,0x30	10	80
	7050075	503	2,0x30	10	96
	7050076	633	2,03x30	10	118
	7050077	803	3,0x30	10	219
	7050078	1003	3,0x30	10	270
	7050079	1253	3,0x30	5	329

VUGGE SYREFAST A4 HULLDIAMETER Ø11					
	7051071	633	2x30		357 /stk
	7051072	803	3x30		655 /stk
	7051073	1003	3x30		810 /stk
	7051074	1253	3x30		995 /stk

TRAPEZHENGER M8/10					
	7051693	Syrefast A4	1		109 /stk
	7051078	Varmforzinket	m/hull 8-10		35
	7051079	Magnelis	m/hull 8-10		50

SYREFAST SLAGANKER A4

	7050956	M 8		100x	47	/stk

GJENGESTAG

	7051691	2000	Syrefast	M 8	225	
	7051692	2000	Syrefast	M 10	274	
	Leveres i 2 meters lengde. Bunter à 25 stk					
	7051122	8x2000	Varmforsinket FZV		199	
	7051123	10x2000	Varmforsinket FZV		158	

SKIVE RUND DIN125 A4

	7051689	Syrefast	M 8	100x	3	
	7051690	Syrefast	M 10	100x	3	

FLENSMUTTER

	7051064	M 8	Syrefast	100x	24	
	7051065	M10	Syrefast	100x	28	
	7050928	M8	Varmforsinket FZV	100x	2	
	7050927	M10	Varmforsinket FZV	100x	4	
	7050930	M12	Varmforsinket FZV	100x	8	

SEKSKANTSKRUE

	7051687	Syrefast	M 8x30	200x	19	
	7051688	Syrefast	M10x30	100x	15	
	7050925	Varmforsinket FZV	M8x30	200x	4	
	7050926	Varmforsinket FZV	M10x30	100x	7	

MARUTEX

RISE-sertifisert montasje skrue i rustfritt spesialstål. Spesialherdet borspiss. Kan også brukes ved montasje av Magnelis. Korrosivitetsklasse C5. Benytt særskilt montasjehylse 031-50 for å unngå jernsmuss.

	7053945	TG12	Dim: 4,2x13	Kap. 2x1,0	Bits: 1/4	1000x	3 990	
	7053953	B62 m/skive	Dim: 4,8x20	Kap. 2x2,0	Bits: 8 mm	250x	1 720	

SYREFAST NAGLER A4

	7050878		3,2x8 mm	500x	925	

SYREFAST EKSPANSJONSBOLT A4

	7051068		12x103	20x	2 100	pkn
	ESA7-sertifisert. Benyttes ved innfesting av ventilasjonstårn o.l.					

SYREFAST GRUNNPLATE A4

	7051694	M 8/10	30x80mm	50x	223	



SYREFAST LANGMUTTER A4

	7051066	M 8x40	Syrefast	50x	112	
	7051067	M10x50	Syrefast	100x	200	
	7051022	M8x40	Profin C4E		16	

SYREFAST BLADHYLSE A4						
	7051069		M 8	100x		49
	7051070		M 10	100x		74

MAGNELIS BLADHYLSE PROFIN C4E						
	7051055		M 8			17
	7051056		M 10			23

Disse bladhylsene benyttes der det skal være Magnelis mot syrefast

SYREFAST WIRE						
	7050966	Wire, 5mm rustfri. Bruddstyrke: 1232 kg	50 m rull			3 800
	7050967	Wireklemme AISI 316	5 mm rustfri			99
						

SYREFAST STREKKFISK						
	7050968	Strekfisk lukket - AISI 316	8 mm			390
	Til bruk ved bardunering/stramming av wire					

MAGNELIS PENDELFESTE						
	7051054		3x2000			520

KORROSIVITETSKLASSER OPPHENG – INNFESTING

MATERIALE/ YTTERBEHANDLING	MATERIALTYPE	PRODUKT EKSEMPEL	KORR.KLASSE
Elforzinket	FZB	Stativrør	C1
Galv.plate	FFZV Z275	Pendelfeste, klammer	C3
Varmforzinket	FZV	Konsoller, skruer, mutter gjengestag	C4
Aluzink	AZ185	Klammer	C4
Rustfri	1.4301 RF 2333 A2 AISI304	Band,	C4
Profin C4E	Profin C4E	Bladhylse, langmutter, borskruer	C4
Magnelis	ZM310	Pendelfeste, klammer	C5
Syrefast	1.4401 RF 2348 A4 AISI316L	Gjengestag, skruer, grunnplate, langmutter, bladhylse, eks.bolt. slaganker, klammer, vugger, trapeshenger	C5
Marutex	Rustfritt spesialstål	Skruer	C5

PENDELFESTE

	7051054	2000 mm	262
	Runde hull Ø11 25mm deling. Slissehull 36 x 11 mm, 50 mm deling 30x30x30x3,0 mm EI60		



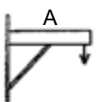
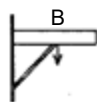
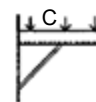



KONSOLL M/STØTTE | VARMFORSINKET FZV



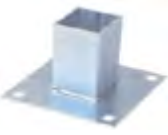

	  			7051111	250	117																															
	<table border="1"> <thead> <tr> <th>Bærearm lengde mm</th> <th>Belastning A</th> <th>Belastning B</th> <th>Belastning C</th> </tr> </thead> <tbody> <tr> <td>250</td> <td>1,50 kN</td> <td>3,00 kN</td> <td>3,00 kN</td> </tr> <tr> <td>300</td> <td>1,50 kN</td> <td>2,75 kN</td> <td>2,75 kN</td> </tr> <tr> <td>400</td> <td>1,00 kN</td> <td>2,50 kN</td> <td>2,50 kN</td> </tr> <tr> <td>500</td> <td>0,75 kN</td> <td>2,00 kN</td> <td>2,00 kN</td> </tr> <tr> <td>600</td> <td>0,75 kN</td> <td>1,50 kN</td> <td>1,50 kN</td> </tr> <tr> <td>800</td> <td>0,75 kN</td> <td>1,50 kN</td> <td>1,50 kN</td> </tr> <tr> <td>1000</td> <td>0,50 kN</td> <td>1,25 kN</td> <td>1,25 kN</td> </tr> </tbody> </table>			Bærearm lengde mm	Belastning A	Belastning B	Belastning C	250	1,50 kN	3,00 kN	3,00 kN	300	1,50 kN	2,75 kN	2,75 kN	400	1,00 kN	2,50 kN	2,50 kN	500	0,75 kN	2,00 kN	2,00 kN	600	0,75 kN	1,50 kN	1,50 kN	800	0,75 kN	1,50 kN	1,50 kN	1000	0,50 kN	1,25 kN	1,25 kN	7051117	300
Bærearm lengde mm	Belastning A	Belastning B	Belastning C																																		
250	1,50 kN	3,00 kN	3,00 kN																																		
300	1,50 kN	2,75 kN	2,75 kN																																		
400	1,00 kN	2,50 kN	2,50 kN																																		
500	0,75 kN	2,00 kN	2,00 kN																																		
600	0,75 kN	1,50 kN	1,50 kN																																		
800	0,75 kN	1,50 kN	1,50 kN																																		
1000	0,50 kN	1,25 kN	1,25 kN																																		
			7051112	400	140																																
			7051113	500	160																																
			7051114	600	189																																
			7051115	800	282																																
			7051116	1000	321																																

STATIVBYGGESYSTEM

For rask oppbygging av ulike typer stativ. Systemet består av stativrør, samt ulike byggedetaljer for ulike konstruksjoner. Monteringen skjer med selvborrende skruer av type Supertex 4,8x19 mm. Stativrør/deler i stål kvalitet 1312.



	STATIVRØR					
	35x35x1,5 L=3 m		7051095			438
	HJØRNE					
	40x40x2		7051096	25		112 /stk.
	FOT					
	40x40x2		7051097	25		60 /stk.
	T-RØR 90 GR.					
	40x120		7051098	25		80 /stk.
	VINKEL 90 GR.					
	40x120		7053679	25		83 /stk.
	UTV/INNV.VINKEL 45 GR.					
	40x40x2		7051101	25		147 /stk.
	VEGGFESTE					
	40x40x2		7051099	25		57 /stk.

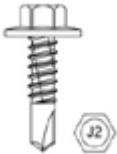

	MELLOMSTYKKE RETT				
	40x250 mm		7051102	25	91 /stk.
	T-RØR 45 GRADER				
	40x40x2x120		7051105		131
	RØRBESKYTTERE				
	- Passer til:	35x35-Innv.	7051106		7
		35x35-Utv.	7051107		16
		40x40-Innv.	7051108		10
		40x40-Utv.	7051109		19
	MELLOMSTYKKE 45 GR.				
	40x40x2		7051103	25	90
	HJØRNEKRYSS				
	40x40		7051104	10	196
	SUPERTEX SKRUE				
	4,8x19 Borrende skrue med sekskanthode og flens. Til stativrørmontasje.		7050917	250	287



Komplett geidsystem for skjøting av rektangulære kanaler.
Anerkjent gjennom en årrekke og stadig forbedret.

BUNTER

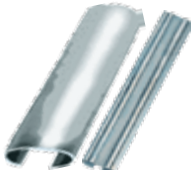
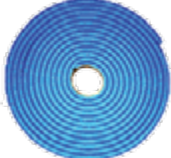













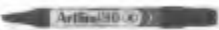

Geidkant = 1500m
Geidskinne=1000m









	ABRA GEIDKANT LEV. I 5-METERE				
	ABRA Geidkant 5,0 m	100 m	7051124		50 /m.
	GEIDKANT 99 (Ahlund,LS1)	100 m	7051135		51 /m.
	ABRA Geidkant Magnelis	100 m	7051133		60 /m.
	ABRA GEIDSKINNE 2,5 M				
	ABRA Geidskinne slett	100 m	7051126		31 /m.
	Geidskinne 99		7051136		28 /m.
	ABRA Geidskinne Magnelis	100 m	7051134		35 /m.
	Galv. 0,7 Lev. i 2,5 metre. Leveres i slett utførelse.				
	TETNINGSLIST BLÅ				
	Lett å henge opp på verkstedet.				
	ABRA tetningslist, blå på rull		7051125	500 m	8 /m.
	Tetningslist til Skarv 99, L-profil		7051137	500 m	7 /m.
Tetningslist bør aventes montert ifm montasje					
	STAGHJØRNE, STORT				
	Galv	150x150	7051128		40
	Magnelis	150x150	7053996		46



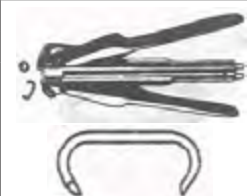



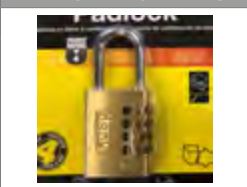



	STAGHJØRNE, LITEN				
	Galv	60x60	7051130		12
	YTTERHJØRNE M/HULL				
	Galv		7051127	500x	7 /stk.
	Magnelis		7051132	500x	27 /stk.
	SIKKERHETSHJØRNE				
	Innvendig, lang type				
	Sikkerhetshjørne ABRA	Galv	7051131	600x	8 /stk.
	Sikkerhetshjørne ABRA - 80x80	Magnelis	7053997	600x	9
	Innerhjørne til Geid 99	Galv	7051138	1500x	2
	DRENERINGSKOPP				
	Lev. Med gjengemuffe 3/4"		7051129	15x	335 /stk.
	ABRA GEIDERDOR				
	Med SDS+ feste. For å drive inn skyveskinne.		7051171		1 090
	KOMBITANG MANUELL				
			7051169		3 700
	KOMBITANG, TRYKKLUFT GOLD KV3-27/8A				
			7051170		29 190
HYDRAULISK KLIPPE					
Pris på forespørsel					
	Ombygging med utbytte av gjæringsverktøy				
	Pris på forespørsel				



	STUBAI PLATESAKSER					
	Høyre	7051141	280mm	grønn	1 430	
	Venstre	7051142	280mm	rød	1 430	
	BACHO PLATESAKSER (MED TANNING)					
	Høyre - 583D -grønn	7051139	280		1 090	
	Venstre - 584D - rød	7051140	280		1 090	
	STUSSAKS TIL SPIRO					
	Gap: 65 mm	7051143	460		7 400	
	Res.skjær	7051144			585	
	WISS-SAKSER					
	M2R/HØ	7051145	250		840	
	M1R/VE	7051146	250		840	
	MIDWEST FASONGSAKSER MOD.6510 IDEELL FOR VENT.MONTASJE					
	Høyre	7051147	280		920	
	Venstre	7051148	280		920	
	BLIKKENSLAGERHAMMER TRESKAFT OG KILE STUBAI					
		7051149	400		327	
	HULTAFORS BLIKKENSLAGERHAMMER "TOR"					
		7051150	300		1 170	
		7051151	400		1 400	
	PLUMB SNEKKERHAMMER PROFF					
	Genial patent som holder fast spikeren	7051153	16 Oz		625	
	PLASTKLUBBE					
	Rektangulær	7051152	155x85x35 mm		885	
	BAUFILBUE - HULTAFORS HMX 12"					
	Profesjonell baufilbue med kompakt alu-ramme. Ergonomisk håndtak.	7051154	300 mm		755	
	BAUFILBLAD 32 T HSS TOPPKVALITET					
	Baufilblad 32T 2-pack	7051155	300 mm		67	
	STIKKSAG					
	Lengde 310 mm	7051156	310 mm		453	

HÅNDVERKSKNIVER						
	Mora - 546 BLÅ	7053681				147
	Mora - 746 ERGO	7051161				197
	Hultafors Grov kniv	7051163				198
	Hultafors - HÅNDVERKSKNIV Rustfri	7051162				176
HULTAFORS BRYTEBLADKNIV						
	BRYTEBLADKNIV	7051249	SRP-18W	B: 18mm x L: 100 mm		171
	Ergonomisk brytebladkniv for allsidig bruk f.eks skjæring i gips, isolasjon, våtromsplater etc. Symmetrisk design for både høyre- og venstrehånd bruk.					
	BRYTEBLAD, ALLROUND	7051250	SBA 18-4x3	B: 18mm x L: 100 mm		163
	BRYTEBLAD, PERFORMANCE	7051251	SBP 18-4x3			348
Leveres i en praktisk pakke med 4 magasiner og 3 kniver i hver.						
LEATHERMAN						
	WAVE+ Black	7051285				2 000
						NETTO PRIS
	Leatherman OHT, sort	7051286				1 910
						NETTOPRIS
UTSTYR TIL BRANNTETTING						
	MURERSETT 4 deler	7051164				505
	MØRTELRØRER	7051165	420x85 mm			133
POP TANG TT 55						
	Poptang TT 55	7051168	250			494
VANNPUMPETANG						
	Vannpumpetang KNIPEX COBRA 7"	7051172	240	7"		960





SPIROTANG						
	Godt egnet for klipping av "kjøtt-tjuver" på spirorør, ved kapping. Knipex	7051176				1 390
FALSÅPNERTANG						
		7051179	250			1 370
FALSETANG BØYD 45 GR.						
		7053682	60			1 620
RISSEMÅL ENKELT						
		7051193				259
MERKEPENNER						
	Standard	7051181	10x/pk			55 /stk
HULTAFORS						
	Merketusj - sort	7051182				108
	Merkeblyant	7051183				273
	Merkeblyant - refill	7051184				164
						
MÅLEBAND						
		7051192	5 m			885
VATER						
	PLAST GDS40	7051186	400			477
	M/MAGNET	7051187	400			1 850
	TORPEDOVATER M/MAGNET	7051188	230			350
						
TALLMETER						
	Med hvitt emaljert band. Oppfellbar måletunge for innvendig måling. Gradert i mm på en side samt med en diameterskala (Pi-skala) som ved omkretsmåling direkte angir sylinderdiameteren.	7051189	3 m			615
METERSTOKKER						
	TRE mm/tommer	7051190	2 m			174
	Glassfiber G59 mm	7051191	2 m			305
ISOLERINGS-SAKS						
	Lang type	7051196	950			1 350

ISOLERINGSKNIV					
		7051197	479		350
NETTINGBINDER					
		7051198			312
ISOLERINGSTRÅD 0,7 GALV.					
		7051199			19
KLAMMERTANG P7 TIL NETTINGMATTER					
		7053683	190		2 440
	Klammer til P7 Pk a 2500 stk.	7051201			371
KLAMMERPISTOL T64-OCS					
	Til stifting av lamellmatter	7051202			2 540
KLAMMER 694/12					
	20 pk - klammer til T64	7051203	5000 pr pk		433
VERKTØYBÆRER					
		7051195			396
	Hultafors nye verktøybærer gjør dagen lettere. Den har avrundet bakside som er tilpasset låret, håndtaket kan slås ned eller bli stående oppe og den er klargjort for å sette på skulderstropp. Verktøybæren er lett å stable med tilsvarende bøtter. Produsert i solid PP-plast, har måleskala på innsiden og tåler 100 kg.				
HENGELÅS M/KODE - KLASSE 4					
		7051194	40 mm		400
UNBRACOSETT M/HOLDER					
	Lang type	7051204			312
FOX BITS-SETT					
		7051216		31 deler	284

MAGNETHOLDERE					
 	7053943	Magnet holder Unite			75
	7051206	1/4"			94
	7051207	7 mm			86
	7051208	8 mm			86
	7051209	10 mm			90
	7051210	13 mm			84
	7053944	Hylse med kule 1/4" 50 mm			86
	7053994	Hylse med kule 8 mm 50 mm			86
GJENGESTAGHYLSE					
	Hylsen griper M8 gjengestag uten å deformere gjengen.	7051223	M8		258
1/4" PIPE LANG					
		7051217	10 mm		96
KVALITETSBITS -3-PACK					
	PH-2	7051219			55
	TORX T20	7053684			52
	TORX T30	7051221			52
	PH-2 lang 150	7051222			105
BITS-SETT VENTILASJON					
		7051215			525
BITSSETT MED SKRALLE 1/4"					
		7051214		2058/S26	995
BITSSETT PROPACK					
	ProPack	7051218			231
BITSHOLDER LANG 15 CM					
		7051213			214
BECONOR BITSHOLDER - EKSTRA LANG					
		7051212	30 cm		448
KOMBINØKKEL M/SKRALLE					
	1/4"	7051175			393
	10 mm	7051173			378
	13 mm	7051174			483





BATTERIER					
	LR6-1,5V	7051229		4x	86
	LR6-1,5v-AA	7051227		4x	94
	LR03-1,5v-AAA	7051228		1x	110
KABELTROMMEL, GODKJ. UTENDØRS BRUK					
		7051230	25 m		1 930

PROFFSERIE 55PN					
		Typegodkjent proffstrapp. Plattform og stålstag låser trappen i utslått posisjon.			
		7051244	5		8 300
		7051243	6		9 180
		7051245	7		10 340
	W.steps rekkverk	7051247			4 500
	W.steps stige fot type 2	7051246			3 230
	W.steps støtteben WTb SB7*	7051248			2 950
		* Støtteben gjør basen til trappestigene bredere og reduserer risikoen for at trappen velter sidelengs.			
HITAC-LIFTEN					
	Løftehjelpemiddel for sirkulære kanaler Leveres parvis. HMS i praksis.	7051166			1 640 NETTOPPRIS
HITAC TABLE					
	Kappebenk for spiro, med regulerbar arbeidshøyde. Lett å ta med seg, sammenfellbar. Vekt 17 kg. Lengde: 2400 mm Innfelt: 1070 mm. Diam: Ø80 - Ø400.	7051167			15 330 NETTOPPRIS
MONTASJEHANSKER					
	Hanske Handi-2382 - helstrikket nylon m/myk PU	7051231	str 9	12 par	90
	Hanske Handi-2383 - helstrikket nylon m/myk PU	7051232	str 10	12 par	90
	MaxiFlex Endurance	7051233	str 9	Par	155
	MaxiFlex Endurance	7051234	str 10	Par	155
Montasjehanske med ekstremt god passform i nylon/lycra med nitril-belegg i håndflaten, fingrene og håndbaken. Sertifisert. Allergitestet. Full gripekontroll!					
	Worksafe CUT-3 Str.9	7051235		Par	131
	Worksafe CUT-3 Str.10	7051236		Par	131
Antall i pkn: 6					

VERNEBRILLER					
	PROFF	7051237			188
OVERTREKKSDRESS					
	BRUK & KAST, hvit	7051239	XL		176
STØVMASKE					
	P2	7051238		1 stk	88
LASTESTRAMMER					
	500 kg	7053685			134
LASTESURRING					
	5 meter - 200 kg	7051242	2.pack		130







NETTOPRISER

	Klarer 4x0,75 mm. Ingen brannfare, kanaler forblir rene, intet støv, tidsbesparende, ingen grader			
	For gradfri klipping. Klarer å klippe over falsen på kanaler opptil Ø800. Ett "must" for ventilasjonsmontasje.			
DRÄCO PÅSTIKKSAKS 3514-7R				
	7050004		11 210	
DRÄCO-SAKS ACCU AK 3514-7R 18V				
	2 Li-Ion batteri (2.0 Ah + 4.0 Ah), Lader 30 min og koffert	7051255	19 760	
	Ekstra batteri 18V 4.0 Ah Li-Ion	7051262	4 670	
				
RESERVEDELER				
	Låsesett BG35055	7051253	BG35055	404
	Skrue M3x8-81439 til fjærplate	7051254	81439	25
	Kniv-7R	7051256	371401	1 920
	Bakker-7R	7051257	BG37222	1 230
	Aksling m/innerring og lager (54,55,58,60-62)	7051258	BG35556	1 470
	Fjær 12200 (13065)	7051259	12200	89
	Fjærplate 12300 (13064)	7053686	12300	237
	Skrue for bakker M4x8-81286	7051261	81440	25



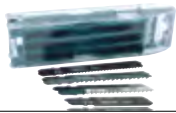

MAKITA PLATESAKS				
	Makita platesaks Z-modell, kapasitet i stål 1,6 mm, 18V	7051267	DJS161Z	3 320
	Makita knivblad midtskjær 1,6	7051265	792534-4	805
	Makita sideskjær 1,6	7051266	792533-6	630
MAKITA SLAGSKRUTREKKER LXT				
	18V • 1/4" • 180 Nm • 0 - 3 600 min ⁻¹	7051269	DTD173Z	2 250
	Kraftig 18V slagskrutrekker med børsteløs motor, 4 hastigheter og 4 bruksinnstillinger. DTD173 er meget smal bare 111 mm lang. Den har bitsfeste med to kulelager som stabiliserer og reduserer vingling, og hurtig innfesting. Maskinen har 4 momentinnstillinger samt 4 predefinerte funksjoner til spesifikke oppgaver og reversfunksjon for å løsne bolter og muttere med god kontroll. Bryterpanelet sitter bak for lettere tilgang.			
MAKITA BORSKRUTREKKER				
	Børsteløs motor, 2000 o/min, dobbel LED-beslysning	7051268	DDF484RTJ	3 600
	Metallgir. High-end proff modell. 54 Nm			
	Leveres med: 2x 18V/5.0 Ah batterier, hurtiglader og Makpac koffert			
MAKITA KOMBIHAMMER 18V				
	2x 5,0 Ah + lader og støvavsug HEPA	7051270	DHR243ZJW	4 540
MAKITA BAJONETTSAG				
	Z-modell 18V	7051271	DJR187Z	2 320
	0-3000 min - 32mm			
MAKITA SIRKELSAG				
	18V 136mm 3600 min.	7051272	DCS552	2 100
	Erstatter vinkelsliper (varme arbeider)			
MAKITA BLÅSEPISTOL				
	LXT 18V	7053928	DAS180Z	1 910
	Kompakt, lett og kraftig 18V blåsepistol. Ypperlig til servicepersonell for rengjøring av filter, rister, aggregat, kanaler m.m. Kan også reverseres, det vil si tømme ut luft. Leveres i eske uten batteri og lader. 5 forskjellige dyser medfølger.			
MAKITA BATTERI/BATTERILADER/BATTERIPAKKE				
	Batterilader	7051275	DC18RC	910
	Batteri 18 v 5,0 Ah	7051274	BL 1850B	1 100

MAKITA SIRKELSAGBLAD				
		7051273	B-33526	665
BAJONETTSAGBLAD				
	52 mm. Til urent trevirke med metall	7051276	B-49834	212
	228 mm. Til urent trevirke med metall	7051277	B-49840	291
	305 mm. Til urent trevirke med metall	7051278	B-49856	327
	6 pack. For tre.	7051279	B-44432	265
	150x0,9 mm. For metall	7053687	B-16841	149
	225x0,9 mm. For metall	7051281	B-16776	238
STIKKSAGBLADER SETT				
	5 stk	7051282	B-44426	333
	3 stk supermix	7051283	B-06292	111
LANGPIPE				
	Langpipe 13x300MM 1/4"	7051284	B-52598	385

Din tekniske totalleverandør av ventilasjonsprodukter

OSLO (Hovedkontor)

Stanseveien 28
0976 Oslo
Tlf. 23 33 82 00
firmapost@swegon.no

STAVANGER

Fabrikkveien 29
4033 Stavanger
Tlf. 51 81 00 30
stavanger@swegon.no

BERGEN

Sandbrekkeveien 96
5225 Nesttun
Tlf. 55 20 68 60
bergen@swegon.no

TRONDHEIM

Fossegrenda 7
7038 Trondheim
Tlf. 73 95 64 00
trondheim@swegon.no

BODØ

Påls vei 4
8008 Bodø
Tlf. 75 99 01 10
bodo@swegon.no

TROMSØ

Stakkevollveien 49
9010 Tromsø
Tlf. 77 66 87 50
tromso@swegon.no

Feel good **inside**



Swegon 